



EUROPEAN  
COMMISSION

European  
Research Area

# Long-term Performance of Engineered Barrier Systems PEBS

Contract (grant agreement) number: **FP7 249681**

Combined report for:

**DELIVERABLE (D-N°:D2.3-1)**

**Feasibility report on GAME mock-ups  
&**

**DELIVERABLE (D-N°:D2.3-2.1)**

**Report on GAME status, 1<sup>st</sup> period**

Author(s):

CIEMAT: P.L. Martín and J.M. Barcala

Date of issue of this report: **31/12/11**

Start date of project: **01/03/10**

Duration: **48** Months

<b>Project co-funded by the European Commission under the Seventh Euratom Framework Programme for Nuclear Research &amp; Training Activities (2007-2011)</b>		
<b>Dissemination Level</b>		
<b>PU</b>	Public	PU
<b>RE</b>	Restricted to a group specified by the partners of the [PEBS]	
<b>CO</b>	Confidential, only for partners of the [PEBS] project	





## **TABLE OF CONTENTS**

<b>1</b>	<b>GENERAL DESCRIPTION AND OBJECTIVES .....</b>	<b>1</b>
<b>2</b>	<b>COMMON COMPONENTS OF THE TESTS .....</b>	<b>2</b>
2.1	CONFINING STRUCTURE .....	2
2.2	HYDRATION SYSTEM .....	4
2.3	HEATING SYSTEM .....	6
2.3.1	<i>Heater</i> .....	6
2.3.2	<i>Heater monitoring and control systems (HCS)</i> .....	8
2.4	INSTRUMENTATION .....	9
2.4.1	<i>Instrumentation rods</i> .....	10
2.5	INSTALLATION OF COMPONENTS .....	11
2.6	SENSOR DISTRIBUTION AND CODING .....	13
2.7	DATA ACQUISITION SYSTEM (DAS).....	14
2.7.1	<i>DAS hardware</i> .....	15
2.7.2	<i>DAS software</i> .....	17
2.7.3	<i>Installation of the components</i> .....	18
<b>3</b>	<b>SPECIFIC COMPONENTS OF THE TESTS.....</b>	<b>21</b>
3.1	BARRIER MATERIALS: CLAY AND CONCRETE .....	21
3.1.1	<i>Design of the barrier</i> .....	21
3.1.2	<i>Fabrication of clay blocks</i> .....	22
3.1.3	<i>Fabrication of concrete blocks</i> .....	23
3.2	TYPE OF WATER AND CONTROL.....	24
<b>4</b>	<b>SET-UP MODIFICATIONS .....</b>	<b>26</b>
4.1	ROTATION OF THE STRUCTURES .....	26
4.2	NEW SUPPORTS .....	27
4.3	INSTALLATION OF DAS.....	29
<b>5</b>	<b>OPERATION AND RESULTS .....</b>	<b>30</b>
5.1	HYDRATION .....	30
5.1.1	<i>NF-PRO phase</i> .....	30
5.1.2	<i>PEBS phase</i> .....	33
5.2	HEATING .....	34
5.2.1	<i>NF-PRO phase</i> .....	35
5.2.2	<i>PEBS phase</i> .....	36
5.3	TH BEHAVIOUR.....	36
5.3.1	<i>NF-PRO phase</i> .....	36
5.3.2	<i>PEBS phase</i> .....	49
<b>6</b>	<b>CONCLUSIONS .....</b>	<b>66</b>
<b>7</b>	<b>REFERENCES .....</b>	<b>68</b>

---

[PEBS]

D2.3-1: [Feasibility report on GAME mock-ups](#) & D2.3-2.1: [Reports on GAME status, 1<sup>st</sup> report](#)

Dissemination level: PU

Date of issue of this report: **December 2011**

## **LIST OF FIGURES**

Figure 1-1: General scheme of the GAME test.....	1
Figure 2-1: Structure: (up) FEM model of the and final design; (down) stresses in the cover and the core.....	2
Figure 2-2: Main parts of the structure: external cylinder, heater core,annular cover and heater flange.....	3
Figure 2-3: Hydration system: accumulator vessel and detail of the load cells. ....	4
Figure 2-4: Heaters core and SS316L mesh. ....	7
Figure 2-5: Heater core: resistances, sensors and thermal isolation. ....	8
Figure 2-6: HCS: MLC9000+ controller, relays and fuses, and transformers.....	9
Figure 2-7: Internal distribution of the sampling levels: A) Level 1; B) Level 2; C) Level 3; and D) auxiliar element.....	10
Figure 2-8: Instrumentation rod: set of pieces before insertion of guide-tube. ....	11
Figure 2-9: Sequence of original assembly of the rods: insertion of the guide-tubes, assembly of levels (detail and general), and final aspect. ....	11
Figure 2-10: Installation of the barrier: clay and concrete/clay tests. ....	12
Figure 2-11: Original location of the structures.....	12
Figure 2-12: Installation of the instrumentation rods and connection to DAS.....	12
Figure 2-13: DAS structure: general configuration of the system ....	15
Figure 2-14: Sensirion EK-H3 multiplexer. ....	16
Figure 2-15: General view of the experiments conditions.....	17
Figure 2-16: Example of screen showing data and accessible elements of heaters .....	18
Figure 2-17: General view and description of the initial DAS 19"-rack.....	19
Figure 2-18: General view and description of the initial UPS 19"-rack.....	20
Figure 3-1: Geometry of the clay barrier in test S1: end section.....	21
Figure 3-2: Geometry of the clay-concrete barrier in test S2 .....	22
Figure 3-3: Forms of the molds A and B.....	22
Figure 3-4: Concrete blocks: dimensions and stocked in the wet room. ....	24
Figure 3-5: Differential pH18 sensor with EXA PH402 transmitter.....	24
Figure 3-6: Yokogawa GCh transmitters installed on the DAS 19"-rack. ....	25
Figure 3-7: Inductive Conductivity Meter ISC40G with EXA ISC402 transmitter.....	25
Figure 4-1: Final position of the structures after modifications: two-rod side. ....	26
Figure 4-2: Final position of the structures after modifications: three-rod side.....	27
Figure 4-3: Sensirion SHT75 transmitters: description and dimensions. ....	27

---

[PEBS]

D2.3-1: [Feasibility report on GAME mock-ups](#) & D2.3-2.1: [Reports on GAME status, 1<sup>st</sup> report](#)

Dissemination level: PU

Date of issue of this report: **December 2011**

Figure 4-4: New support for RH-T transmitters: parts and assembly. ....	28
Figure 4-5: New water sampling port: original/modified parts and assembly. ....	28
Figure 4-6: Final I/O in the structure: detail. ....	29
Figure 4-7: New view and description of the DAS 19"-rack ....	29
Figure 5-1: Mass of water, pH and temperature: initial phase, test S1. ....	31
Figure 5-2: Mass of water, EC and temperature: initial phase, test S2. ....	32
Figure 5-3: Test S1 hydration: injected water, pH and temperature.....	33
Figure 5-4: Test S2 hydration: injected water, EC and temperature. ....	34
Figure 5-5: Heater temperatures from the controller: initial phase, test S1. ....	35
Figure 5-6: Heater temperatures from the controller: initial phase, test S2. ....	35
Figure 5-7: Heater temperatures from the controller: test S1.....	37
Figure 5-8: Target temperatures from the controller: test S1 .....	37
Figure 5-9: Heater temperatures from the controller: test S2.....	38
Figure 5-10: Target temperatures from the controller: test S2. ....	38
Figure 5-11: Test S1 NF-PRO phase: RH and T values from rod A: sensors A0, A1, A2 located at coordinates (X= - 0.3; Y= 0.395, 0.315, 0.225, respectively).....	39
Figure 5-12: Test S1 NF-PRO phase: RH and T values from rod B: sensors B0, B1, B2 located at coordinates (X= 0.0; Y= 0.405, 0.295, 0.205, respectively).....	40
Figure 5-13: Test S1 NF-PRO phase: RH and T values from rod C: sensors C0, C1, C2 located at coordinates (X= 0.3; Y= 0.425, 0.335, 0.245, respectively).....	41
Figure 5-14: Test S1 NF-PRO phase: RH and T values from rod D: sensors D0, D1, D2 located at coordinates (X= - 0.15; Y= 0.445, 0.355, 0.265, respectively).....	42
Figure 5-15: Test S1 NF-PRO phase: RH and T values from rod E: sensors E0, E1, E2 located at coordinates (X= 0.3; Y= 0.465, 0.375, 0.285, respectively).....	43
Figure 5-16: Test S2 NF-PRO phase: RH and T values from rod A: sensors A0, A1, A2 located at coordinates (X= - 0.3; Y= 0.395, 0.315, 0.225, respectively).....	44
Figure 5-17: Test S2 NF-PRO phase: RH and T values from rod B: sensors B0, B1, B2 located at coordinates (X= 0.0; Y= 0.405, 0.295, 0.205, respectively).....	45
Figure 5-18: Test S2 NF-PRO phase: RH and T values from rod C: sensors C0, C1, C2 located at coordinates (X= 0.3; Y= 0.425, 0.335, 0.245, respectively).....	46
Figure 5-19: Test S2 NF-PRO phase: RH and T values from rod D: sensors D0, D1, D2 located at coordinates (X= - 0.15; Y= 0.445, 0.355, 0.265, respectively).....	47
Figure 5-20: Test S2 NF-PRO phase: RH and T values from rod E: sensors E0, E1, E2 located at coordinates (X= 0.3; Y= 0.465, 0.375, 0.285, respectively).....	48
Figure 5-21: Test S1 PEBS phase: RH and T values from rod A: sensors A0, A1, A2 located at coordinates (X= - 0.3; Y= 0.395, 0.315, 0.225, respectively) .....	50
Figure 5-22: Test S1 PEBS phase: RH and T values from rod B: sensors B0, B1, B2 located at coordinates (X= 0.0; Y= 0.405, 0.295, 0.205, respectively) .....	51
Figure 5-23: Test S1 PEBS phase: RH and T values from rod C: sensors C0, C1, C2 located at coordinates (X= 0.3; Y= 0.425, 0.335, 0.245, respectively).....	52

---

**[PEBS]**

D2.3-1: [Feasibility report on GAME mock-ups](#) & D2.3-2.1: [Reports on GAME status, 1<sup>st</sup> report](#)

Dissemination level: **PU**

Date of issue of this report: **December 2011**

Figure 5-24: Test S1 PEBS phase: RH and T values from rod D: sensors D0, D1, D2 located at coordinates (X= - 0.15; Y= 0.445, 0.355, 0.265, respectively).....	53
Figure 5-25: Test S1 PEBS phase: RH and T values from rod E: sensors E0, E1, E2 located at coordinates (X= 0.3; Y= 0.465, 0.375, 0.285, respectively) .....	54
Figure 5-26: Test S1 PEBS phase: RH and T values from outer levels: (X, Y) location: A0(-0.3, 0.245), B0(0.0, 0.255), C0(0.3,0.275), D0(-0.15, 0.295), E0(0.15, 0.315).....	55
Figure 5-27: Test S1 PEBS phase: RH and T values from intermediate levels: (X, Y) location: A1(-0.3, 0.165), B1(0.0, 0.145), C1(0.3, 0.185), D1(-0.15, 0.205), E0(0.15, 0.225) .....	56
Figure 5-28: Test S1 PEBS phase: RH and T values from inner levels: (X, Y) location: A2(-0.3, 0.075), B2(0.0, 0.055), C2(0.3, 0.095), D2(-0.15, 0.115), E2(0.15, 0.135).....	57
Figure 5-29: Test S2 PEBS phase: RH and T values from rod A: sensors A0, A1, A2 located at coordinates (X= - 0.3; Y= 0.395, 0.315, 0.225, respectively) .....	58
Figure 5-30: Test S2 PEBS phase: RH and T values from rod B: sensors B0, B1, B2 located at coordinates (X= 0.0; Y= 0.405, 0.295, 0.205, respectively) .....	59
Figure 5-31: Test S2 PEBS phase: RH and T values from rod C: sensors C0, C1, C2 located at coordinates (X= 0.3; Y= 0.425, 0.335, 0.245, respectively).....	60
Figure 5-32: Test S2 PEBS phase: RH and T values from rod D: sensors D0, D1, D2 located at coordinates (X= - 0.15; Y= 0.445, 0.355, 0.265, respectively).....	61
Figure 5-33: Test S2 PEBS phase: RH and T values from rod E: sensors E0, E1, E2 located at coordinates (X= 0.3; Y= 0.465, 0.375, 0.285, respectively) .....	62
Figure 5-34: Test S2 PEBS phase: RH and T values from outer levels: (X, Y) location: A0(-0.3, 0.245), B0(0.0, 0.255), C0(0.3,0.275), D0(-0.15, 0.295), E0(0.15, 0.315).....	63
Figure 5-35: Test S2 PEBS phase: RH and T values from intermediate levels: (X, Y) location: A1(-0.3, 0.165), B1(0.0, 0.145), C1(0.3, 0.185), D1(-0.15, 0.205), E0(0.15, 0.225) .....	64
Figure 5-36: Test S2 PEBS phase: RH and T values from inner levels: (X, Y) location: A2(-0.3, 0.075), B2(0.0, 0.055), C2(0.3, 0.095), D2(-0.15, 0.115), E2(0.15, 0.135).....	65

---

**[PEBS]**

D2.3-1: [Feasibility report on GAME mock-ups](#) & D2.3-2.1: [Reports on GAME status, 1<sup>st</sup> report](#)

Dissemination level: **PU**

Date of issue of this report: **December 2011**

## LIST OF TABLES

Table 2.1: Average coordinates of instrumentation levels .....	14
Table 3.1: Average values of the physical properties and number of blocks installed .....	23
Table 3.2: Average values of the physical properties and number of blocks installed .....	23
Table 5.1: Series of injections of water: initial phase, test S1.....	31
Table 5-2: Series of injections of water: initial phase, test S2.....	32
Table 5.3: Series of injections of water: test S1.....	33
Table 5.4: Series of injections of water: test S2.....	34

---

[PEBS]

D2.3-1: [Feasibility report on GAME mock-ups](#) & D2.3-2.1: [Reports on GAME status, 1<sup>st</sup> report](#)

Dissemination level: PU

Date of issue of this report: **December 2011**

# 1 GENERAL DESCRIPTION AND OBJECTIVES

The Geochemical Advance Mock-up Experiments (GAMES) have been designed to accomplish the following objectives:

- Research on the potential changes that may occur in the key parameters of the buffer material as a result of thermo-hydro-mechanical (THM) and thermo-hydro-geochemical (THG) processes.
- Monitoring geochemical (G) changes by using specific sensors or by sampling, without interference with the system.
- Evaluation of the performance and long-term behaviour of the G monitoring systems.
- By the improvement of the knowledge of the THG(M) processes in the EBS, the GAMES will enable to improve the calibration and validation of the THG(M) numerical models with “on line” GCh information, not a final picture after dismantling

The GAME tests simulate the components of the engineered barriers system (EBS) in accordance with the ENRESA AGP Granite and Clay reference concepts (ENRESA, 1994 and 1995). The tests are installed in the same test room of the THM Mock-up experiment of RTDC 3, at CIEMAT facilities in Madrid, Spain. The building is air-conditioned, so that the temperature is maintained around 20°C).

The original infrastructure of the tests consist of five basic units, represented in Figure 1-1: the confining structure that includes the surfaces for hydration and heating, the hydration system, the heating control system (HCS); the clay barrier, the instrumentation (external and internal), and the data acquisition systems (DAS).

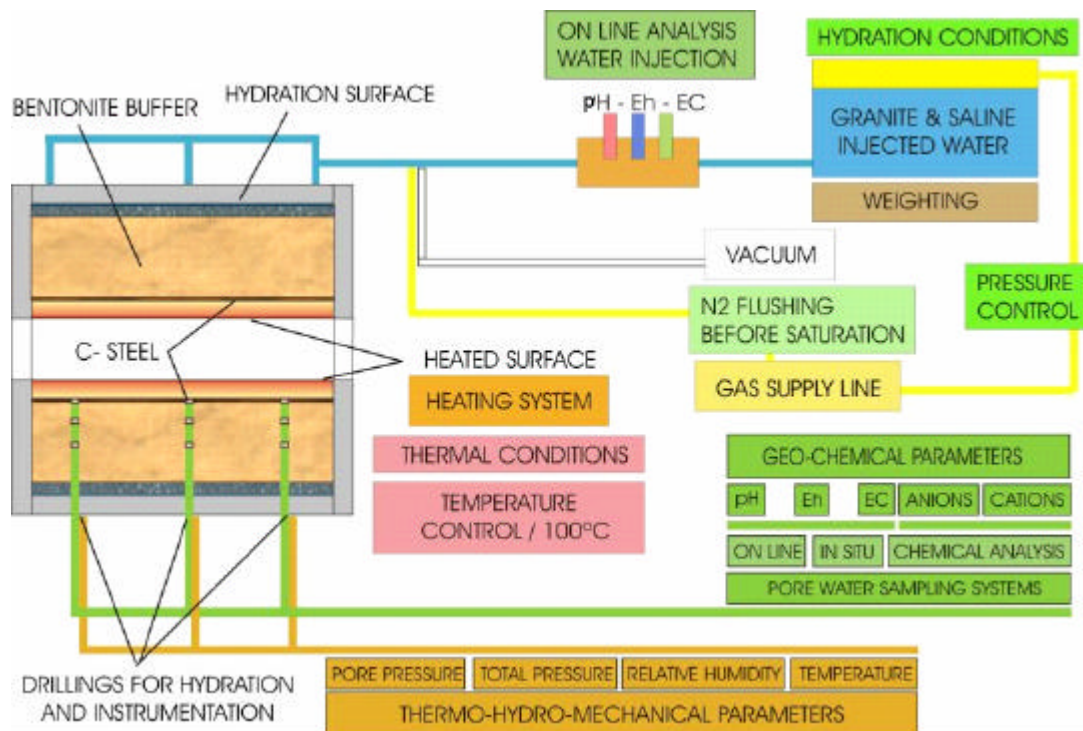

Figure 1-1: General scheme of the GAME test

[PEBS]

D2.3-1: Feasibility report on GAME mock-ups & D2.3-2.1: Reports on GAME status, 1<sup>st</sup> report

Dissemination level: PU

Date of issue of this report: December 2011



## 2 COMMON COMPONENTS OF THE TESTS

This section describes the main elements of the experimental setup (Martín & Barcala, 2077 a-b) that have not been changed or modified in a significant way during the operational life of the tests.

### 2.1 Confining structure

A FEM model was developed in CIEMAT to obtain the final design of the structure and to calculate the dimensions (Figure 2-1). Two concentric cylindrical bodies, closed with two annular covers, compose the confining structure, completely made of SS316L. The whole set was placed on a mobile metallic bed.

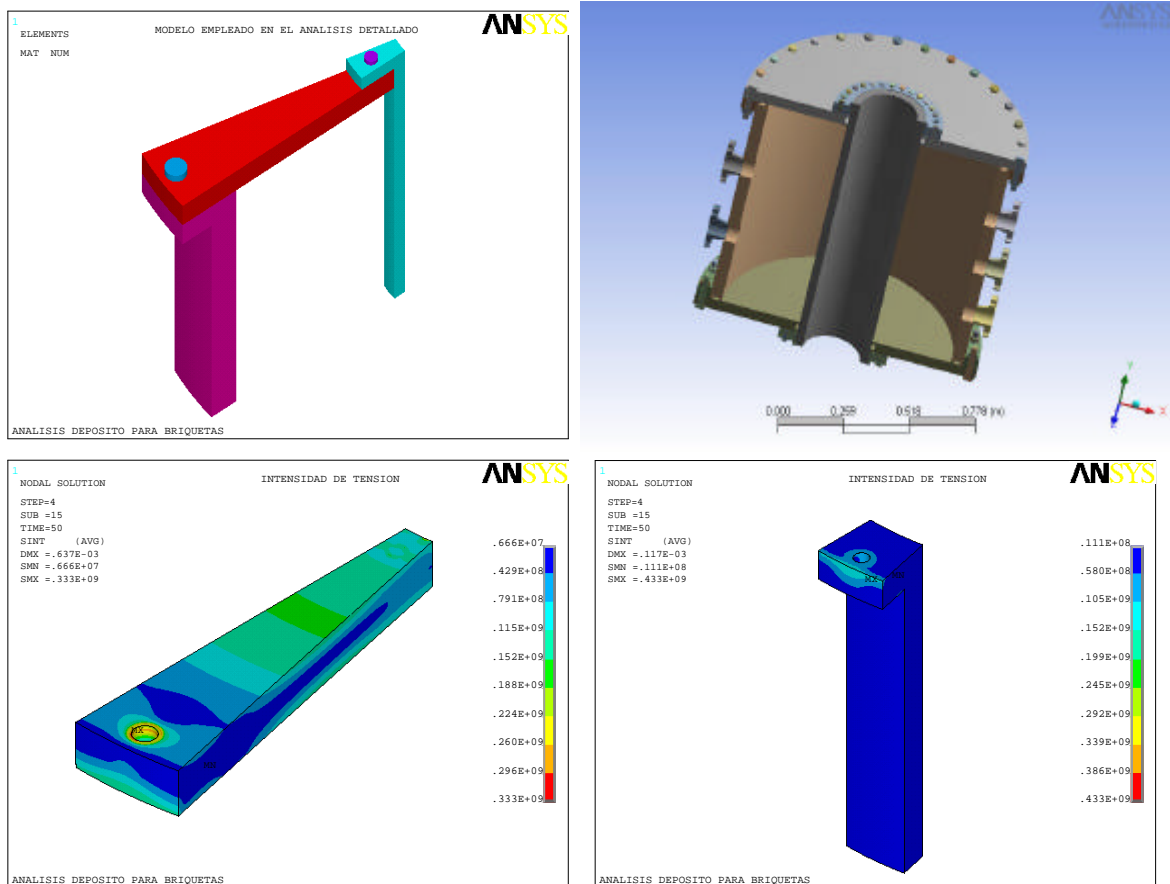

**Figure 2-1: Structure: (up) FEM model of the and final design; (down) stresses in the cover and the core.**

The main characteristics of the confining structure are as follows:

Inner diameter	0.94m
Inner length	1.00 m
Wall thickness	0.05 m
Design pressure	5 MPa
Total empty mass (estimated)	5280 kg

[PEBS]

D2.3-1: Feasibility report on GAME mock-ups & D2.3-2.1: Reports on GAME status, 1<sup>st</sup> report

Dissemination level: PU

Date of issue of this report: December 2011

In each end cover there is an exit for the power and temperature sensor cables from the heaters.

The external cylinder of the confining structure is perforated in 29 points: 5 large-diameter I/Os for insertion of the instrumentation rods, 6 medium-diameter I/Os for the exit of sensor cables, and 18 small-diameter I/Os for water injection (Figure 2-2)

The inner cylinder blocks the strains of the annular covers under pressure and provides the heating surface of the experiment. The heating surface is divided in eight zones controlled independently. The total power supply is around 2000 W/heater.



**Figure 2-2: Main parts of the structure: external cylinder, heater core,annular cover and heater flange.**

The manufacture's dossier (VICALDE, 2005; Llodio, Spain) includes the inspection point program (IPP) accepted by CIEMAT, the quality certificates of the materials, the welding procedure specifications (WPS), the welder performance qualification (WPQ), as well as the liquid penetrant and radiographic examinations. The "as built" dimensional control is also included.

---

[PEBS]

D2.3-1: [Feasibility report on GAME mock-ups](#) & D2.3-2.1: [Reports on GAME status, 1<sup>st</sup> report](#)

Dissemination level: PU

Date of issue of this report: **December 2011**

## 2.2 Hydration system

This system supplies water for hydration of the bentonite mass, at a constant and controlled pressure.

The system consists of a tank with a total capacity of approximately 0.3 m<sup>3</sup> that supplies water through a network of pipes joined to the 18 water injection nozzles in the confining structure. It is located as close as possible to the structure, to reduce the dead volume of the system (Figure 2-3).

The hydration water is pressurized through N<sub>2</sub> gas. The tank is actually a surge alleviator, acting as a hydro-pneumatic accumulator vessel. The accumulator consists of a sealed steel shell, which contains a rubber bladder. This diaphragm acts as a flexible barrier between the water and the nitrogen gas and prevents its dissolution.

The tanks are supported on three metallic legs, where three load cells let us weight the loss of mass, which corresponds to the injected water.



**Figure 2-3: Hydration system: accumulator vessel and detail of the load cells.**

The basic elements of the system are as follows:

Nitrogen line under 2.0 MPa pressure

OLAER AAV300-25 Hydro-pneumatic accumulator vessels, with the following characteristics:

Material	Carbon steel
Height	1.475 m
Diameter	0.63 m
Working pressure	2.5 MPa
Test pressure	3.7 MPa
Internal volume (estimated)	0.3 m <sup>3</sup>
Total empty mass (estimated)	202 kg

Weighting system for measurements

---

[PEBS]

D2.3-1: [Feasibility report on GAME mock-ups](#) & D2.3-2.1: [Reports on GAME status, 1<sup>st</sup> report](#)

Dissemination level: PU

Date of issue of this report: **December 2011**

Network of pipes to the confining structure

Filters and geotextile for the protection of the water injection points (nozzles).

Geotextile lines the interior surface of the confining structure. The purpose of the geotextile lining is to homogenize the water supply around the periphery of the barrier.

The parts of the system in contact with the water are of stainless steel, AISI 316, or elastomer.

The hydration tank has been pressure-tested at a pressure 1.5 times the nominal design pressure and witnessed by independent inspection authority. It was supplied with their corresponding quality certificates and the conformity with 97/23 CE is approved.

### **Connection to the confining structure**

The connection between the hydration system and the confining structure is made by means of 18 injection points distributed in three sections, each section with six injection nozzles distributed at 60° and connected to a pipe ring. Water is injected through nozzles protected with SS filters to avoid clogging by the clay.

The internal surface of the confining structure is covered with two layers of geotextile that compose a homogeneous surface of hydration for the barrier. The properties of compressibility and permeability of this geotextile (TERRAM 4000 from Exxon) were verified by laboratory tests.

### **Monitoring and control of the hydration water supply**

Load cells and pressure sensors control the mass and injection pressure of the water supplied to the confining structure. The values obtained are sent directly to the data acquisition system (DAS).

The tank is supported by three metallic legs, at 120°. These lugs are over the load cells, which are seated on the three legs (Figure 2-3). Thus, the mass of water introduced into the system is measured by continuously weighting the hydration tanks. The weighting system for each tank consists of the following elements:

Three flexural load cells HBM Z6FC3/200 (200 kg, connected to 6 wires, 2 mV/V, precision C3, protection IP68, conformity with 90/384 CE is approved), with assembly modulus (anti-spin, anti-overturning, and overload protection).

Shunt connection box HBM VKK1-4, to add the three load cells.

Measurement amplifier/indicator HBM MVD2510 (0.1% precision) with analog output (from 0 to 10 VDC) directly connected to the DAS.

A DRUCK 520DPI pressure controller manages the injection pressure applied to the bladder of the tank.

Using the values from the weighting system and the nitrogen pressure of the hydration tanks, the injected water mass is determined and registered in the DAS.

---

[PEBS]

D2.3-1: [Feasibility report on GAME mock-ups](#) & D2.3-2.1: [Reports on GAME status, 1<sup>st</sup> report](#)

Dissemination level: PU

Date of issue of this report: **December 2011**

## 2.3 Heating system

The system consists of a cylindrical heater and corresponding monitoring and control systems (HCS).

The criterion of the heater operation is that a constant superficial temperature in each zone (a relatively simple control) must maintain the temperature in the heater/bentonite interface at the target one.

### 2.3.1 Heater

#### **General characteristics**

The basic premises in the heater design were to maintain the temperature in the heater/bentonite contact, as homogeneous as possible and the possibility to perform repairs/replacements of the heating elements after installation.

The heater is in direct contact with the bentonite. The electrical heating elements were selected on the basis of the following criteria: efficiency, homogeneous distribution of the heat, power density, cost of installation, lifetime of the elements, and safety aspects.

It has been divided in eight heating zones that can be controlled independently. Each heating zone is heated with four flexible electrical flat resistors. The total power supply installed is about 2000 W.

#### **Mechanical characteristics**

Mechanically, the heater is the central part of the internal cylinder of the structure (that corresponds to the experimental length of the structure). The external dimensions are 1.0 m long and 0.3 m in diameter. As part of the confining structure, the design calculations considered the maximum pressure on the heater zone around 5 MPa.

To protect the heater core surface from induced corrosion during the experiment time, a SS316L mesh was installed around it. The mesh also enhances the corrosion of the tested carbon steel materials (Figure 2-4).

The principal characteristics of each heater are as follows:

External diameter	0.30 m
Length (effective)	1.000 m
Material	Stainless Steel 316L
Wall thickness	0.03 m
Working pressure	5.0 MPa
Elements	MINCO HR5511R8.9L12F with #12 PSA
Sensors	MINCO S467PDZ36B Pt100 with #12 PSA
Nominal maximum power	2000 W
Total empty mass (estimated)	250 kg

---

[PEBS]

D2.3-1: [Feasibility report on GAME mock-ups](#) & D2.3-2.1: [Reports on GAME status, 1<sup>st</sup> report](#)

Dissemination level: PU

Date of issue of this report: **December 2011**



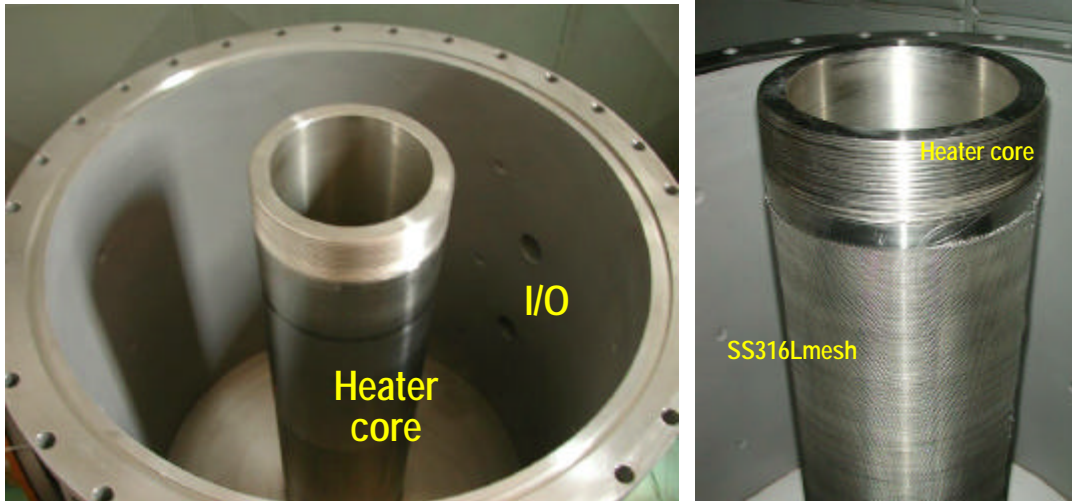

**Figure 2-4: Heaters core and SS316L mesh.**

### **Electrical characteristics**

The heating elements selected are flexible thermo-foils MINCO HR5511R8.9L12F with a pressure-sensitive adhesive (PSA) back. This element has a resistance 8.9 Ohms (with power supply to 220 VAC), has fibreglass reinforced silicon rubber isolation, and withstands temperature to 204°C. Their dimensions are 127x178 mm.

The electrical supply to the heating elements is insulated from the general network by grounded insulating transformers 220-24VAC.

### **Assembly**

The assembly (Figure 2-5) was performed carefully in a sequential process, since the resistors are particularly fragile. In each step, the functioning of the assembled components was verified:

*Installation of the resistances:* the resistances were installed in the inner surface of the heater core. They were fixed by means of the back PSA. Every group of four elements configures a heating zone (0.24 m diameter, 0.125 m length). Thus, eight groups (32 heating elements) form the total heating surface (0.24 m diameter, 1.0 m length). Every two groups (eight elements) are connected to a transformer that is controlled by the HCS.

*Installation of the temperature sensors:* the power control temperature sensors were also installed in the inner surface of the heater core. They are fixed between two heating element of each zone by means of the acrylic PSA back.

*Power supply and sensor cables passage through the end cover:* following installation of all the resistances and sensors, the ends of the resistors and temperature sensor signal cables, each appropriately identified, were passed through protective tubes exiting the heater core. The length of the cables is sufficient to reach the junction box in the HCS, outside the confining structure.

*Heater closure:* after the cables were passed through the pipe, a rock-wool cylinder isolated the internal space from thermal waste and the front ends were closed with a cover.

---

[PEBS]

D2.3-1: [Feasibility report on GAME mock-ups](#) & D2.3-2.1: [Reports on GAME status, 1<sup>st</sup> report](#)

Dissemination level: PU

Date of issue of this report: **December 2011**

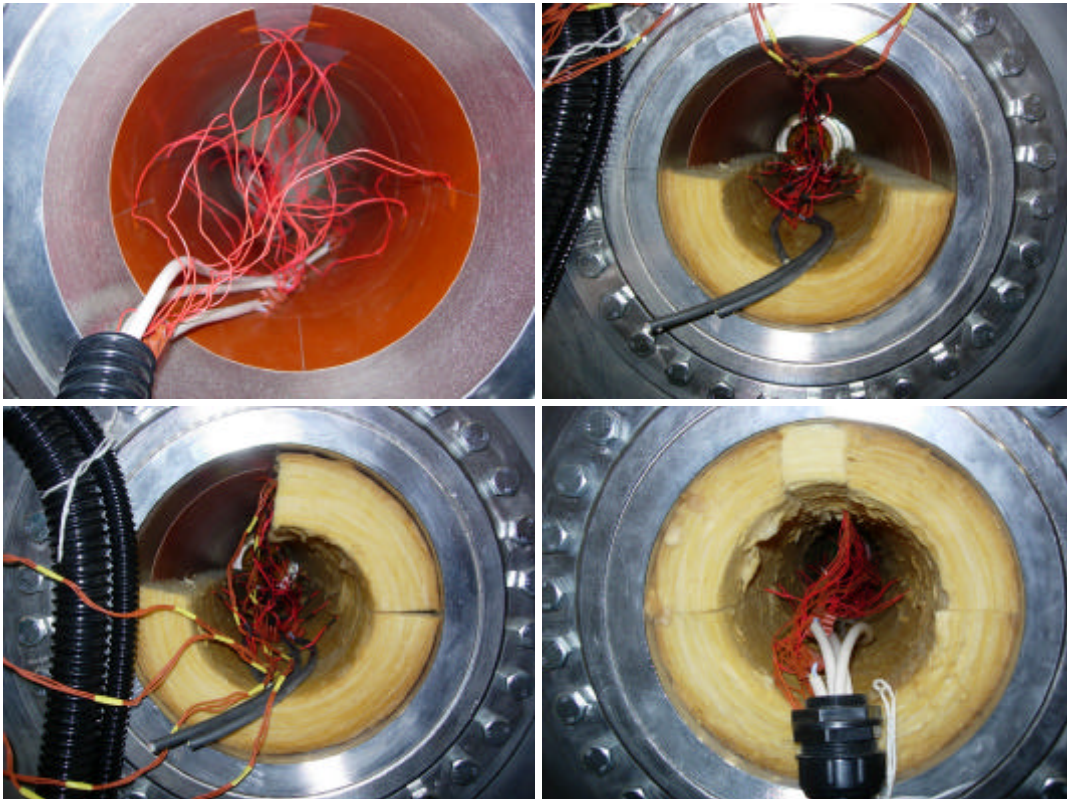

**Figure 2-5: Heater core: resistances, sensors and thermal isolation.**

### 2.3.2 Heater monitoring and control systems (HCS)

The HCS consists of all the electrical and/or electronic components and computer programs for autonomous supervision of the operation and control of the power supply to the heaters, data acquisition (including sending the measurements of the parameters to the DAS); and activation of the processes and alarms in the event of failure of any of the components.

The system is based on a closed loop control with a WEST MLC9000+ Controller that regulates the power supply by means of solid state relays. The four resistors of each zone are controlled as a set.

The control parameter for the heating is the temperature in the inner surface of the cylinder. In the event of failure of any of the heating elements, the control system compensates by using the rest of the heating elements. The eight sensors installed in each heater allow observing the internal temperature distributions.

#### **Main elements of the heater control system**

The HCS is composed of the following subsystems (Figure 2-6):

##### **MLC 9000+ thermal controller**

The controller receives the set-point values from the test control and switches to operation in an autonomous mode, transforming the nominal control parameters to the power supplied to the heater during automatic operation.

The controller measures the temperatures in each heater (at eight points) and controls the temperature value at each section, such that it is equal to the set-point value. The controller makes the calculations, regulates the power by the auxiliary electronics and sends the temperature and instantaneous power data as demanded by the DAS.

---

[PEBS]

D2.3-1: [Feasibility report on GAME mock-ups](#) & D2.3-2.1: [Reports on GAME status, 1<sup>st</sup> report](#)

Dissemination level: PU

Date of issue of this report: **December 2011**

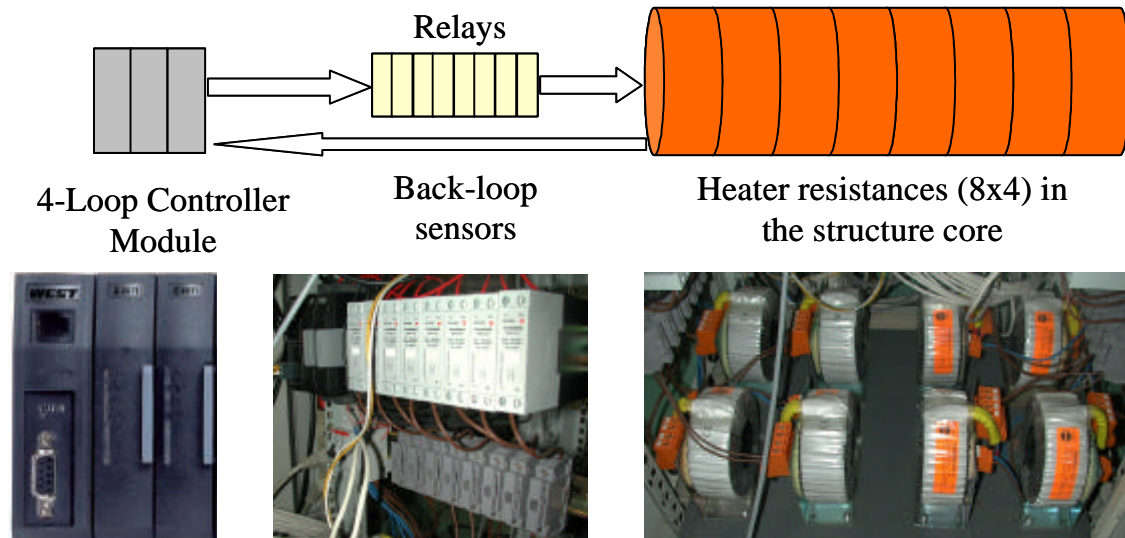

**Figure 2-6: HCS: MLC9000+ controller, relays and fuses, and transformers.**

### **Temperature sensors**

These sensors in the heating surface provide the temperature value for the loop control modules. They are MINCO S467PDZ36B 3-wire Pt100 (13 × 38 mm), with silicone rubber body and leads. Its maximal working temperature is 200°C.

### **Electronic power regulation system**

This system is designed to control the electric power supplied to the resistors. The MLC 9000+ (Danaher Control, 2004) controls the solid state relay, which acts as interrupter for the transformer, regulating conduction time and, consequently, the power supplied to the heater.

### **Heater protection system**

There is an alarm system designed to detect the possible failure of either the heating elements or the critical elements of the power electronics. This is accomplished by detecting variations in the power consumption of any single element.

In the event of failure of a resistor, the system activates the alarm and automatically compensates for the loss.

### **Control procedure**

Any variations occurring in the heater power regime, as changes in the control strategy, must be transmitted to the controller by secure programs, allowing access only to authorized persons.

As it has already been pointed out, all the heating elements in a zone are used simultaneously. This scheme provides the advantage of not subjecting any of the resistors to excessive load, which is important in view of the anticipated duration of the test and the guaranteed mean lifetime of these resistors. This scheme also allows for an instantaneous increase in power without there being an excessive increase in temperature in each resistor.

## **2.4 Instrumentation**

In order to gain insight into the continuous evolution of the variables in the test, the components of the system (heaters, clay barrier, hydration system and confining structure) were instrumented with the appropriate sensors.

---

[PEBS]

D2.3-1: [Feasibility report on GAME mock-ups](#) & D2.3-2.1: [Reports on GAME status, 1<sup>st</sup> report](#)

Dissemination level: PU

Date of issue of this report: **December 2011**



The working conditions (pressure > 5 MPa, temperature up to 80°C, and harsh saline environment) made it advisable to select sensors without active electronic components, when it is possible. Mechanical protection was achieved by means of the instrumentation rods.

#### 2.4.1 Instrumentation rods

Instrumentation rods include three levels of SS316L filters to sample water, connected to chambers with RH and temperature transmitters and G-Ch sensors. All the parts subjected to wetting are made on Teflon and SS316L.

The final design of the elements is shown. The modules that compose the instrumentation rods are either filter elements (to sampling and measurement) or auxiliary elements (to connect different parts). As shown in Figure 2-7, there are common elements: (1) Stainless steel filter; (2) I/O sampling ports; (3) Measurement chambers; (4) Reference electrode chamber; and (5) drills of access to lower levels.

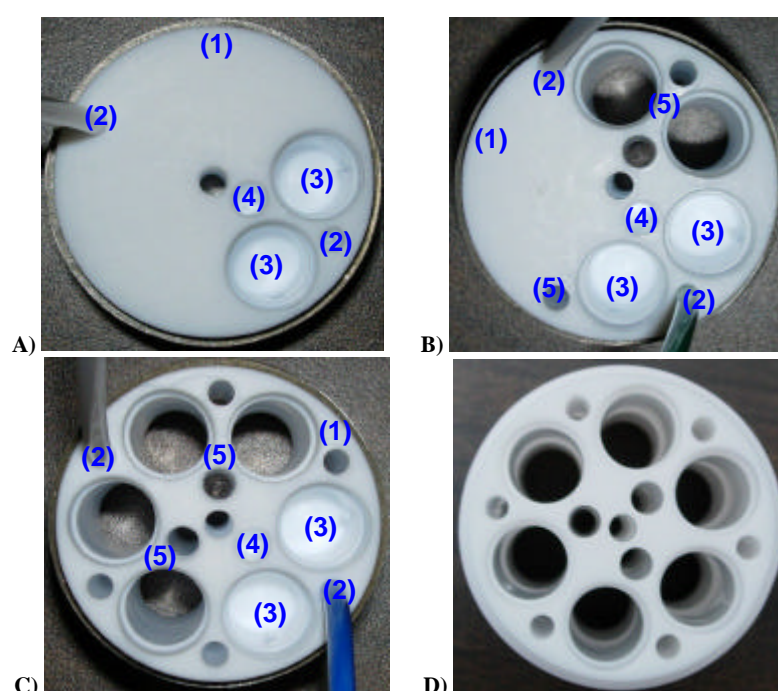

**Figure 2-7: Internal distribution of the sampling levels: A) Level 1; B) Level 2; C) Level 3; and D) auxiliary element.**

Figure 2-8 shows the set of pieces that composes an instrumentation rod: three sampling levels with their internal fittings and I/O sampling lines, the auxiliary block, and the external flange and the external fitting.

Figure 2-9 indicates the sequence of the assembly and the final aspect of the instrumentation rods before installing the electrode probes. The whole set is composed by five rods. A total of 15 filters sample the barrier with their relative positions displaced 0.02 m. In this way, a continuous sampling of the barrier is achieved.

The measurement chambers contain the new supports for the RH-T transmitters and for the water sampling ports.

[PEBS]

D2.3-1: [Feasibility report on GAME mock-ups](#) & D2.3-2.1: [Reports on GAME status, 1<sup>st</sup> report](#)

Dissemination level: PU

Date of issue of this report: **December 2011**

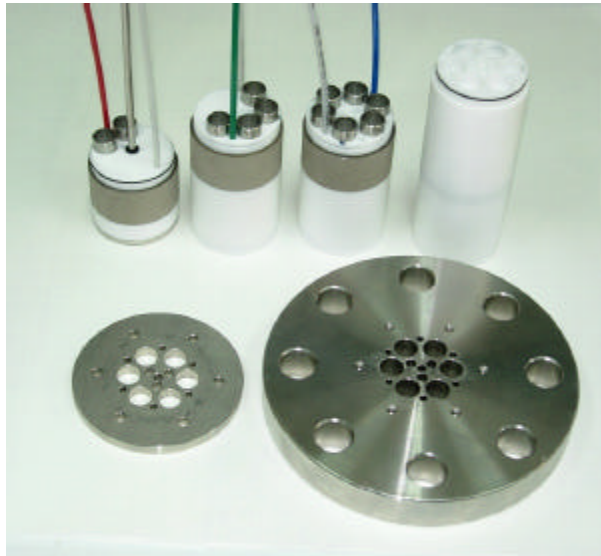

**Figure 2-8: Instrumentation rod: set of pieces before insertion of guide-tube.**

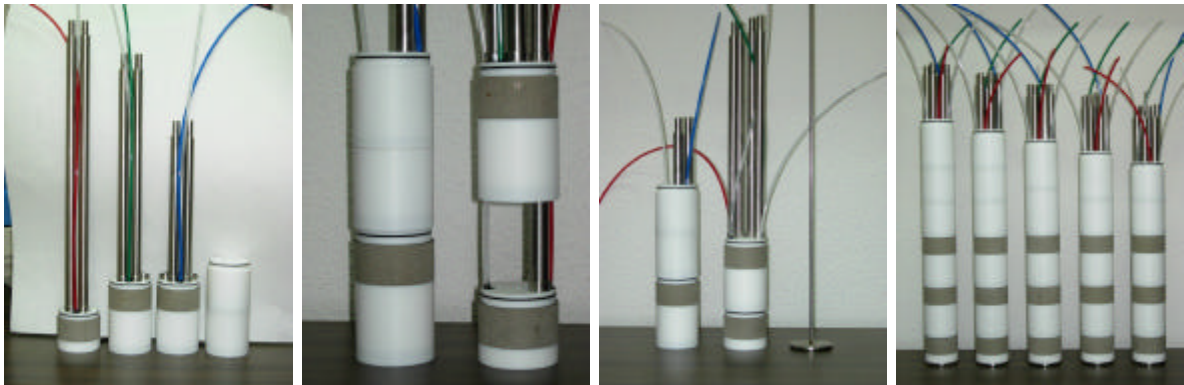

**Figure 2-9: Sequence of original assembly of the rods: insertion of the guide-tubes, assembly of levels (detail and general), and final aspect.**

## 2.5 Installation of components

The installation of the barrier materials in the structure for both experiments (Figure 2-10), and the final positioning in the experiment room (Figure 2-11) were carried out, and the whole set of components were assembled: the structure with the heating core, connected to the heating system, the hydration system connected to the structure, the instrumentation rods installed within the bentonite and fixed to the structure, and the electrical connection of the sensors to the DAS (Figure 2-12).

---

[PEBS]

D2.3-1: [Feasibility report on GAME mock-ups](#) & D2.3-2.1: [Reports on GAME status, 1<sup>st</sup> report](#)

Dissemination level: PU

Date of issue of this report: **December 2011**



**Figure 2-10: Installation of the barrier: clay and concrete/clay tests.**



**Figure 2-11: Original location of the structures.**



**Figure 2-12: Installation of the instrumentation rods and connection to DAS.**

---

[PEBS]

D2.3-1: [Feasibility report on GAME mock-ups](#) & D2.3-2.1: [Reports on GAME status, 1<sup>st</sup> report](#)

Dissemination level: PU

Date of issue of this report: **December 2011**



## 2.6 Sensor distribution and coding

The items to coding the sensors are the type of variable and the location in the experiment. A distinction was made between three main groups of sensors: in the clay barrier, in the heaters, and outside the confining structure.

### Sensors in the clay barrier

Most of the sensors are in the barrier. As explained above, these sensors are grouped in five instrumentation rods—3 in the top of the structure and 2 in the bottom. Each rod has three levels of sampling filters connected to the sensors.

The sensor coding used in the clay barrier is indicated below. Each installed sensor is identified by an alphanumeric code of the following type: **S# XX\_Y\_#**

- #:** 1 for the bentonite experiment; 2 for the bentonite+concrete experiment.
- XX** Variable—T (temperature) and HR (relative humidity).
- Y:** Designation of the rod—A, B, C, D and E
- #:** Numbering of instrumented level as installed in each rod—from 0 to 2, increasing with the radial distance from the hydration surface.

### Temperature sensors on the heaters

These sensors are located on the inner surface of the heater and are distributed in eight sections. All sensors are numbered from 1 to 8. The sensors are displaced 90° from section to section. The control sensor is in the central area of its heating zone and is used to provide the average temperature value used in calculating the power to be supplied to the heater.

These sensors do not follow the general coding rule; they are identified by the following alphanumeric code: **T WX\_#**

- X:** 1 for the bentonite experiment; 2 for the bentonite+concrete experiment.
- T W1:** Temperature point on the heater from West controller
- #:** Numbering of order of installation on the heater, from 1 to 9

### Sensors, instruments, and measurements outside the confining structure

These sensors include all those not dealt with above, such as for example those measuring in the hydration system— weight of the tanks. The calculated values (injected volume of water, average control temperature, and supplied power) are included in this group. No coding system is used for these values.

### Position of the sensors

The sensors are located in the structure following the scheme below.

---

[PEBS]

D2.3-1: [Feasibility report on GAME mock-ups](#) & D2.3-2.1: [Reports on GAME status, 1<sup>st</sup> report](#)

Dissemination level: PU

Date of issue of this report: **December 2011**

ROD A				ROD B				ROD C	
S# A0				S# B0				S# C0	
S# A1				S# B1				S# C1	
S# A2				S# B2				S# C2	
T_W2_1	T_W2_2	T_W2_3	T_W2_4	T_W2_5	T_W2_6	T_W2_7	T_W2_8		
		S# D2				S# E2			
		S# D1				S# E1			
		S# D0				S# E0			
		ROD D				ROD E			

The positions of the sensors taking as origin the centre of symmetry of the heater are described in Table 2.1.

**Table 2.1: Average coordinates of instrumentation levels**

Level	X (m)	Y (m)	Distance to heater (m)
A0	-0,30	0,395	0,245
A1	-0,30	0,315	0,165
A2	-0,30	0,225	0,075
B0	0,00	0,405	0,255
B1	0,00	0,295	0,145
B2	0,00	0,205	0,055
C0	0,30	0,425	0,275
C1	0,30	0,335	0,185
C2	0,30	0,245	0,095
D0	-0,15	0,445	0,295
D1	-0,15	0,355	0,205
D2	-0,15	0,265	0,115
E0	0,15	0,465	0,315
E1	0,15	0,375	0,225
E2	0,15	0,285	0,135

## 2.7 Data acquisition system (DAS)

It includes all the electrical/electronic components, as well as the software necessary to autonomously supervise, register and store on a disk the set of data obtained from the test. It provides conversion of the analogue signals from the transducers into numerical data and performs data conversion and analysis, data display and storage on disk over the long time period (years) that data are being acquired.

---

[PEBS]

D2.3-1: [Feasibility report on GAME mock-ups](#) & D2.3-2.1: [Reports on GAME status, 1<sup>st</sup> report](#)

Dissemination level: PU

Date of issue of this report: **December 2011**

The DAS integrates different types of equipment on a Virtual LAN (Figure 2-13), which allows group instruments in an Ethernet network, without changing any physical connections.

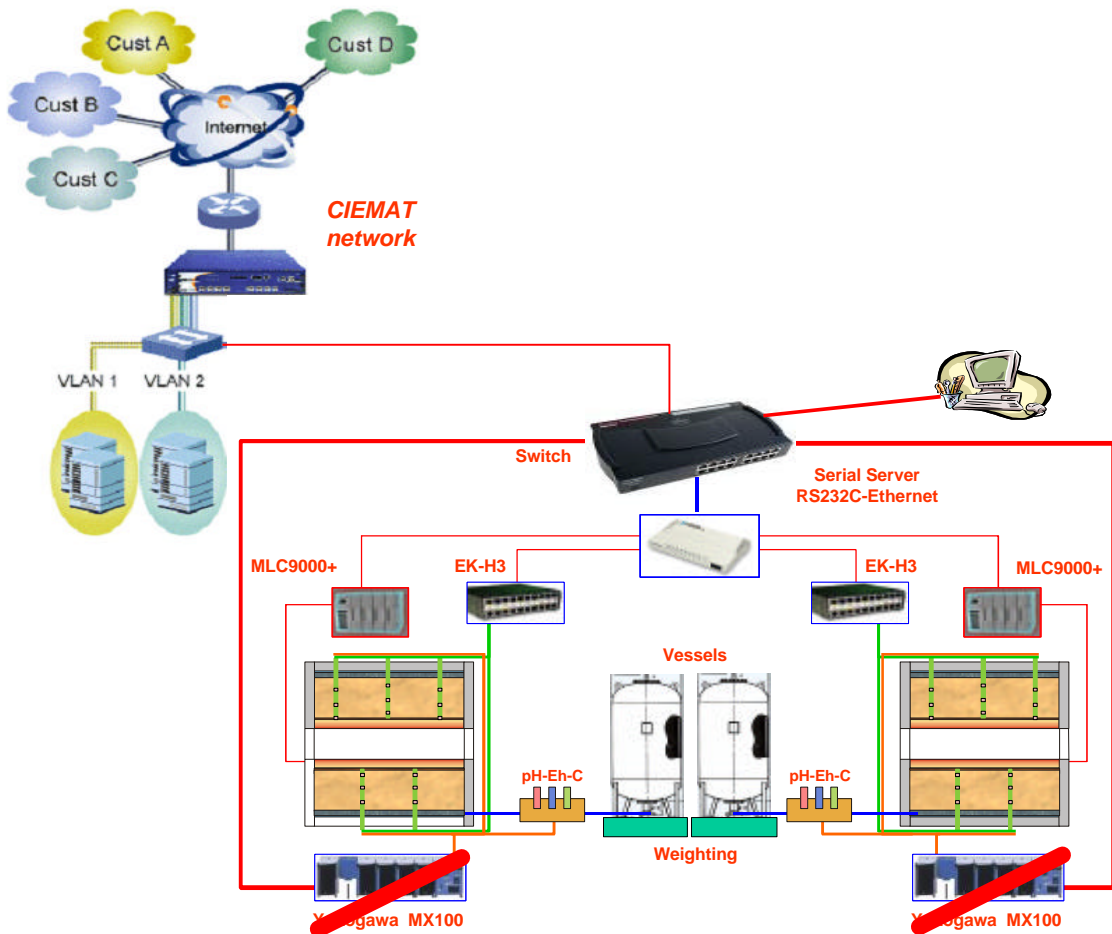

**Figure 2-13: DAS structure: general configuration of the system**

A SCADA (Supervision, Control, And Data Acquisition) program running on a personal computer controls the system, which must acquire, adapt, display and register all the data generated by the installed instrumentation, in real time. The system is autonomous and independent of the HCS.

An OPC server managed under LabView DSC several measurements from: the digital transmitters (relative humidity and temperature) read on a serial specific multiplexer, the Ethernet 8-loops MLC900+ controller (Danaher Controls, 2004) that manages the heating process; and the chemical micro-sensors measured on a Yokogawa MX100 data logger. These last elements have been eliminated of the tests and will not be described or referenced nevermore.

### 2.7.1 DAS hardware

The DAS is composed of the following main elements:

#### **DAS personal computer (DAS PC)**

[PEBS]

D2.3-1: Feasibility report on GAME mock-ups & D2.3-2.1: Reports on GAME status, 1<sup>st</sup> report

Dissemination level: PU

Date of issue of this report: December 2011

The central control of the DAS consists of a PC. The DAS PC is connected simultaneously to the Sensirion EK-H3 multiplexer and to the MLC9000+ controller of the HCS (Figure 2-13) to obtain and register information from the heater.

The DAS PC functions independently, although it is connected to a local network to allow for maintenance and file transfer operations.

### **Sensirion EK-H3 multiplexer**

The EK-H3 multiplexer (SENSIRION, 2003; Figure 2-14) allows the parallel logging of up to 20 humidity and temperature sensors and through some application records the three parameters of relative humidity, temperature, and dew point (calculated) for each individual sensor. The log-file option allows the storage and later evaluation of the obtained measurement data.



**Figure 2-14: Sensirion EK-H3 multiplexer.**

### **Signal conditioning, surge protection and/or electricity supply systems**

After suppression of chemical sensors, the signal conditioning for sensors are provided by the described multiplexers or control systems.

An uninterruptible power system (UPS) is used to guarantee the stability of the electricity protection or supply and to secure the data against supply line surges or failures. Furthermore, each piece of signal conditioning equipment has an adequate protection against surges: each of the metallic elements is connected to its own ground line.

The UPS used is the Extreme 3000+ by MERLIN-GERIN. This equipment functions in accordance with an “in line” scheme; i.e., the output voltage is filtered and isolated from that of the input and has batteries as a buffer. This scheme reduces disturbances of the network to a minimum. The UPS has been designed to operate under normal conditions at 70% of its nominal power, and has a set of auxiliary batteries to maintain autonomy for approximately 20 minutes in the event of power failure.

### **Communication system**

Data transfer between, the DAS computer, the DAS processing units and the HCS is accomplished via a virtual LAN. Some instruments, with RS-232 serial line interfaces only, have been provided with adequate adapters: ENET-232/4 (National Instruments).

---

[PEBS]

D2.3-1: [Feasibility report on GAME mock-ups](#) & D2.3-2.1: [Reports on GAME status, 1<sup>st</sup> report](#)

Dissemination level: PU

Date of issue of this report: **December 2011**

## 2.7.2 DAS software

A generic commercial client-server SCADA system called LabVIEW DSCTM by National Instruments (USA) performs Monitoring and control.

The SCADA application is an OPC client that gets data from the OPC server that recovers data from the MLC9000+ controller. Some LabVIEW functions get Rh and temperature from SENSIRION transmitters (SENSIRION, 2005a-c) with a PC program that communicates with a specific SENSIRION multiplexer via an Ethernet RS-232 serial line adapter.

In addition, the LabVIEW DSC application also performs the following functions to provide all the data:

### Test supervision and display

The graphical characteristics of LabVIEW allow for the creation of personalized screens to display the test parameters and to supervise the test. These screens may be reproduced to document the processes, and other information such as parameters in real time, alarm summaries, histograms, and other graphics may be included on them.

The program gets data from drivers periodically. User has several screens where data are shown in numeric format or in graphics. User can check the time evolution of each sensor. Figure 2-15 and Figure 2-16 show two examples of these screens.



Figure 2-15: General view of the experiments conditions

[PEBS]

D2.3-1: Feasibility report on GAME mock-ups & D2.3-2.1: Reports on GAME status, 1<sup>st</sup> report

Dissemination level: PU

Date of issue of this report: December 2011



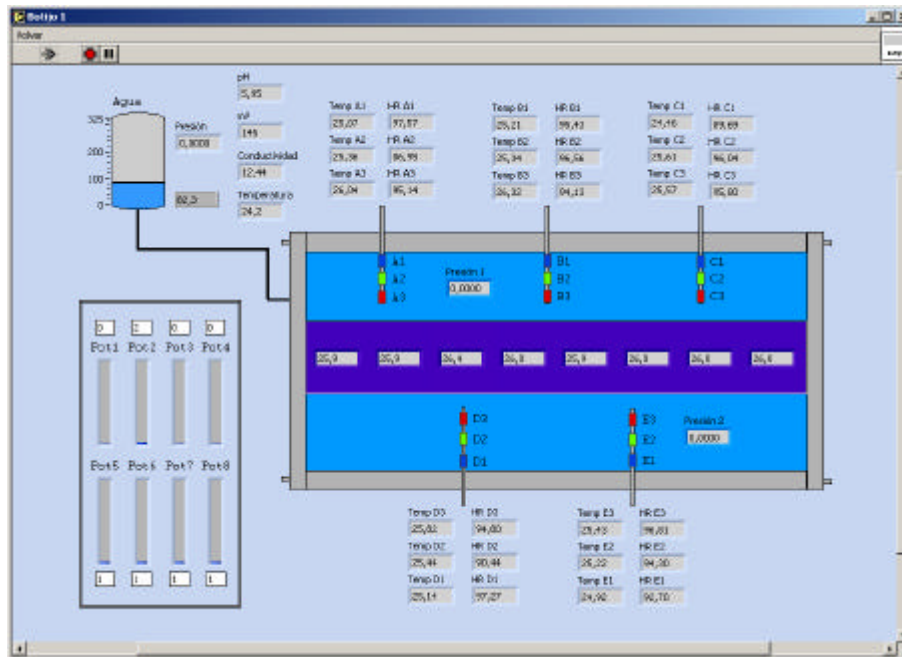

**Figure 2-16: Example of screen showing data and accessible elements of heaters**

Some of the available values from experiment are water inlet, heater power supply and temperatures, RH and temperature in bentonite, and pH and electrical conductivity in the injection water.

The application checks the equipment and the values of the critical sensors periodically.

#### **Data storage and report generation**

The data are stored in ACCESS files generated by the SCADA application, with a frequency selected by the user. The program has its own internal database.

The characteristics of LabVIEW DSC™ allow for the multiple activities of processing, transmitting, and backing up of historic data without destroying either the data log or the alarm management in progress.

The historic files permit the logging, storage and display of process data and analysis of the relationships between variables. The stored data are distributed as periodic reports for the study of processes.

#### **2.7.3 Installation of the components**

The different hardware components of the DAS have been physically integrated in two 19"-racks: one for the DAS electronics (but that includes the HCS, Figure 2-17) and another for the heavy auxiliary elements (UPS and display, Figure 2-18).

[PEBS]

D2.3-1: Feasibility report on GAME mock-ups & D2.3-2.1: Reports on GAME status, 1<sup>st</sup> report

Dissemination level: PU

Date of issue of this report: December 2011

	<p style="text-align: center;"><b>Control PC + Ethernet hub</b></p>
	<p style="text-align: center;"><b>NI Ethernet serial server (x 2)</b></p>
	<p style="text-align: center;"><b>Yokogawa MX100 Datalogger Sensirion multiplexer</b></p>
	<p style="text-align: center;"><b>Yokogawa MX100 Datalogger Sensirion multiplexer</b></p>
	<p style="text-align: center;"><b>HBM 250DV Amplifier (x 2)</b></p>
	<p style="text-align: center;"><b>West MLC9000+ controller Solid state relays Thermal protections</b></p>
	<p style="text-align: center;"><b>220 to 24 VAC 4 converters (x 2)</b></p>

**Figure 2-17: General view and description of the initial DAS 19"-rack**

[PEBS]

D2.3-1: [Feasibility report on GAME mock-ups](#) & D2.3-2.1: [Reports on GAME status, 1<sup>st</sup> report](#)

Dissemination level: PU

Date of issue of this report: **December 2011**

	<p style="text-align: center;"><b>Display</b></p>
	<p style="text-align: center;"><b>Druck DPI520 pressure controller (x2)</b></p>
	<p style="text-align: center;"><b>Merlin Gerin UPS Pulsar Externe 3000 Module EXB 3000 XLA</b></p>
	<p style="text-align: center;"><b>Merlin Gerin UPS Pulsar Externe 3000 Module EXB 3000 XLA</b></p>

**Figure 2-18: General view and description of the initial UPS 19"-rack**

[PEBS]

D2.3-1: [Feasibility report on GAME mock-ups](#) & D2.3-2.1: [Reports on GAME status, 1<sup>st</sup> report](#)

Dissemination level: PU

Date of issue of this report: **December 2011**

### 3 SPECIFIC COMPONENTS OF THE TESTS

#### 3.1 Barrier materials: clay and concrete

In both experiments, the clay barrier was constructed with highly compacted bentonite blocks. The same bentonite was used throughout the FEBEX project, so its THM-G properties are widely described elsewhere (ENRESA, 2006).

Concrete for test S2 is a mixture of sulphate resistant Portland cement (type CEM I-42.5R) and aggregates of quartz sand. The sand/cement ratio is 3:1. The cement/water ratio is 0.6.

##### 3.1.1 Design of the barrier

The dry density specified for the clay blocks is based on considering the anticipated volume of construction gaps and a final dry density of the clay barrier around  $1.6 \text{ g/cm}^3$ . This final value of the dry density corresponds to the design criterion of the ENRESA's reference concepts: AGP Granito and AGP Arcilla (ENRESA 1994, 1995). The water content of the blocks is the hygroscopic for the raw bentonite, from 13.6% to 14.4%.

##### Test S1: clay

Figure 3-1 shows the geometry of the barrier in a section: the external diameter is 0.93m and the internal one is 0.31 m. This geometry is made with two blocks of bentonite: type A (internal ring) and B (external ring).

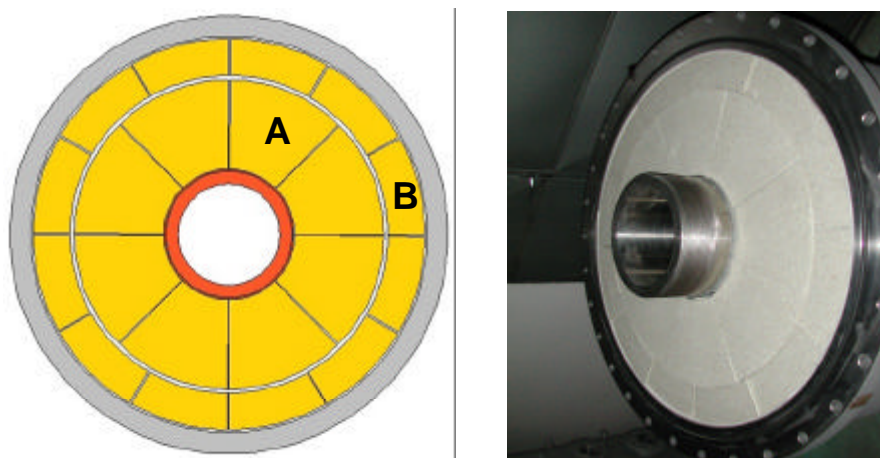

Figure 3-1: Geometry of the clay barrier in test S1: end section

##### Test S2: clay and concrete

Figure 3-2 shows the geometry of the barrier in a section: the external diameter of the bentonite is 0.47m and the internal one is 0.31m. This geometry is made with blocks of bentonite, type A, in the inner ring and blocks of concrete, type B.

---

[PEBS]

D2.3-1: [Feasibility report on GAME mock-ups](#) & D2.3-2.1: [Reports on GAME status, 1<sup>st</sup> report](#)

Dissemination level: PU

Date of issue of this report: **December 2011**



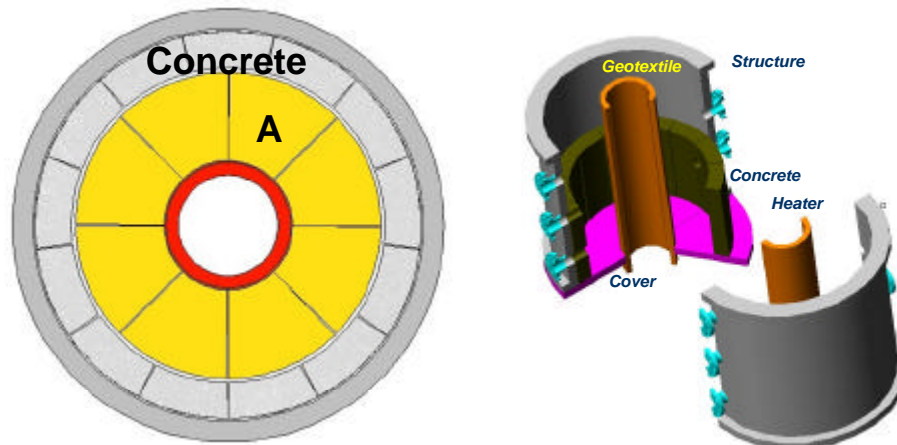

**Figure 3-2: Geometry of the clay-concrete barrier in test S2**

### 3.1.2 Fabrication of clay blocks

Moulds were designed and manufactured for fabrication of the block types A and B. They were manufactured from massive pieces of carbon steel, machined by electro-erosion (Figure 3-3). This technique provides the body of the mould and the male part in one operation.

A single-acting, uniaxial hydraulic press was used to fabricate the blocks, the compaction force being provided by one stroke of 550-600 to 1000-1150 kN, depending on the block surface and mass of bentonite. Both fabrication of the moulds and compaction of the blocks were performed at CIEMAT.

In total, 1695 kg of bentonite were compacted to manufacture 365 blocks. The water content of the bentonite during the compaction was 14.4% (13.6% for the last 84 blocks). The dry density of the blocks was around 1.6 g/cm<sup>3</sup>.

The quality assurance program was applied to the fabrication process: in each block the weight, dimensions, external aspect, dry density and water content were controlled.



**Figure 3-3: Forms of the molds A and B**

### **Test S1: clay**

About 1105 kg of bentonite were compacted to manufacture 365 blocks. The average weighted values of the water content and dry density of the installed bentonite were 14.4% and 1.59 g/cm<sup>3</sup>, respectively.

---

[PEBS]

D2.3-1: [Feasibility report on GAME mock-ups](#) & D2.3-2.1: [Reports on GAME status, 1<sup>st</sup> report](#)

Dissemination level: PU

Date of issue of this report: **December 2011**

Table 3.1 shows the average characteristics and the number of blocks installed in the external and internal ring with the average dry density after expansion of bentonite.

**Table 3.1: Average values of the physical properties and number of blocks installed**

Type of block	A	B
Weight (kg)	6.080	2.680
Water content (%)	14.4	14.4
Dry density (g/cm <sup>3</sup> )	1.56	1.62
Number of installed units	102	156
Total weight (kg)	666	437

### **Test S2: clay and concrete**

About 650 kg of bentonite were compacted to manufacture 104 blocks. The average weighted values of the water content and dry density of the installed bentonite barrier were 13.75% and 1.57 g/cm<sup>3</sup>, respectively.

Table 3.1 shows the average values of the characteristics of blocks.

**Table 3.2: Average values of the physical properties and number of blocks installed**

Type of block	A
Weight (kg)	6.239
Water content (%)	14.4 / 13.6
Dry density (g/cm <sup>3</sup> )	1.60
Number of installed units	104
Total weight (kg)	649

#### **3.1.3 Fabrication of concrete blocks**

Specific moulds were designed and manufactured for fabrication of the concrete blocks. They were manufactured from PVC plate and carbon steel. The set was assembled and filled with the concrete.

After 24 hours, the block was un-moulded and submerged in fresh water during 48 hours. Then, it was placed in a controlled wet room during 20 days (Figure 3-4).

Thirteen blocks (9 cm thickness) that cover completely the geotextile surface compose a half of the concrete ring. Small gaps between blocks permit a faster hydration of the barrier and the expansion of clay through them (Figure 3-1).

The total mass of concrete in the experiment is 519 kg.

---

[PEBS]

D2.3-1: [Feasibility report on GAME mock-ups](#) & D2.3-2.1: [Reports on GAME status, 1<sup>st</sup> report](#)

Dissemination level: PU

Date of issue of this report: **December 2011**



**Figure 3-4: Concrete blocks: dimensions and stocked in the wet room.**

### **3.2 Type of water and control**

For hydration, two types of water are being used and, at the outlet of the tanks, industrial G-Ch sensors analyse the pH or the electric conductivity of the injected water, respectively. These sensors are not integrated in other systems or embedded in the barrier.

#### **Test S1: clay barrier with fresh granitic water**

This water is Grimsel groundwater (received on 19th December 2005 at CIEMAT) from borehole BO – ADUS, close to the Migration shear zone).

A Yokogawa Differential pH18 sensor with an EXA PH402 transmitter measured pH values of the reduced water from GTS (YOKOGAWA, 2005 a-d; Figure 3-5). The sensor is installed on the DAS 19"-rack, as shown in Figure 3-6.



**Figure 3-5: Differential pH18 sensor with EXA PH402 transmitter.**

---

[PEBS]

D2.3-1: [Feasibility report on GAME mock-ups](#) & D2.3-2.1: [Reports on GAME status, 1<sup>st</sup> report](#)

Dissemination level: PU

Date of issue of this report: **December 2011**



**Figure 3-6: Yokogawa GCh transmitters installed on the DAS 19"-rack.**

**Test S2: clay-concrete barrier with saline clay water**

The tank is filled with synthetic RAF water (water from a reference clay formation) made at CIEMAT laboratories. It has a pH of 7.95 and an electrical conductivity of 12.21 mS/cm.

A Yokogawa Inductive Conductivity Meter ISC40G with an EXA ISC402 transmitter (YOKOGAWA, 2005 a-c; Figure 3-7). measures the saline water synthesised at CIEMAT laboratories The sensor is installed on the DAS 19"-rack, as shown in Figure 3-6.



**Figure 3-7: Inductive Conductivity Meter ISC40G with EXA ISC402 transmitter.**

---

[PEBS]

D2.3-1: [Feasibility report on GAME mock-ups](#) & D2.3-2.1: [Reports on GAME status, 1<sup>st</sup> report](#)

Dissemination level: PU

Date of issue of this report: **December 2011**



## 4 SET-UP MODIFICATIONS

The GAME experiment demonstrated that installation of an EBS and the THG instrumentation in a large-scale experiment, with the hydration and heating infrastructures, is feasible for the different HLW repository concepts.

However, due to the detected problems in the experimental set-up, several recommendations were indicated at the end of the NF-PRO project (Martín & Barcala, 2007-e; Turrero et al, 2007).

Following these recommendations, geochemical sensors and the insertion system in the measuring chambers were eliminated and the following setup modifications adopted.

### 4.1 Rotation of the structures

The confining structures were rotated 90° to make easier the access to install these modifications, and to reduce the possibilities of leakage from the instrumentation rods.

The sequence of this operation was:

- 1) The hydration system was closed, the sensors were disconnected from power supply and DAS, and the insertions with the sensors extracted.
- 2) The hydration line was disconnected from the system to permit the rotation of the structure.
- 3) The structure was lifted by two hydraulic jacks to insert several round bars between the structure and its support, so a rolling bed was formed.
- 4) The structure was rotated by a few degrees each time, repeating the step 3 till achieving the target angle: 90°. Then, the structure was lifted one more time to extract the bars and was put down on its support (Figure 4-1 and Figure 4-2).



Figure 4-1: Final position of the structures after modifications: two-rod side.

---

[PEBS]

D2.3-1: [Feasibility report on GAME mock-ups](#) & D2.3-2.1: [Reports on GAME status, 1<sup>st</sup> report](#)

Dissemination level: PU

Date of issue of this report: **December 2011**

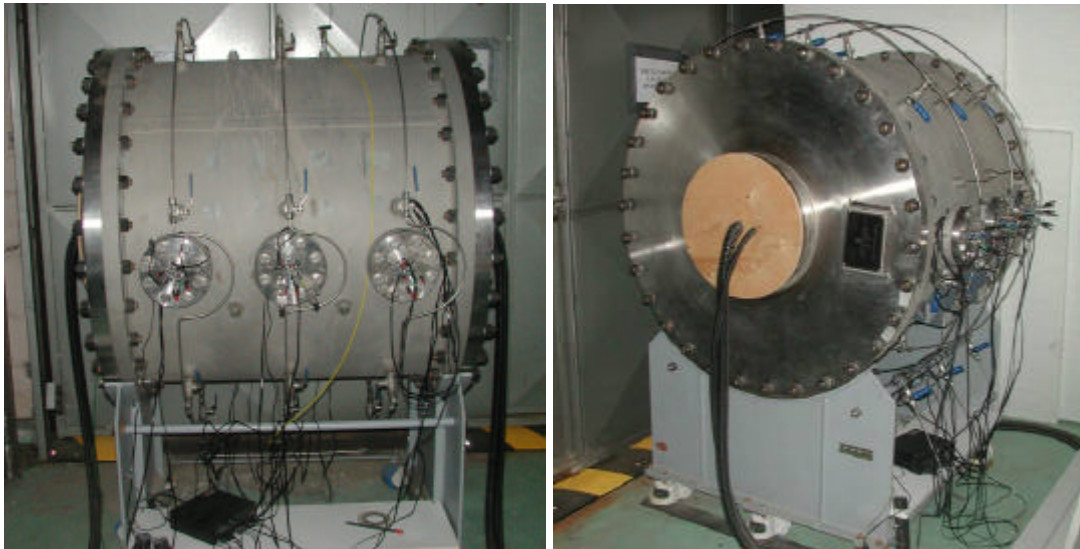

**Figure 4-2: Final position of the structures after modifications: three-rod side**

## 4.2 New supports

The development and implementation of new support systems (for the RH/T transmitters and the water sampling) were the options to correct the problems in the measuring chambers of the instrumentation rods.

### Relative humidity and temperature

SHT75 temperature and RH transmitters are miniature elements (SENSIRION, 2005; Figure 4-3) with a single chip sensor module, fully calibrated with digital 2-wire output. 0-100%, -40 to 120°C, fully interchangeable without recalibration, accuracy +/- 1.8%RH, +/-0.3°C @ 25°C, response time <3s, in a pin-type packaging. They are installed in a SS316 support (Figure 4-4).

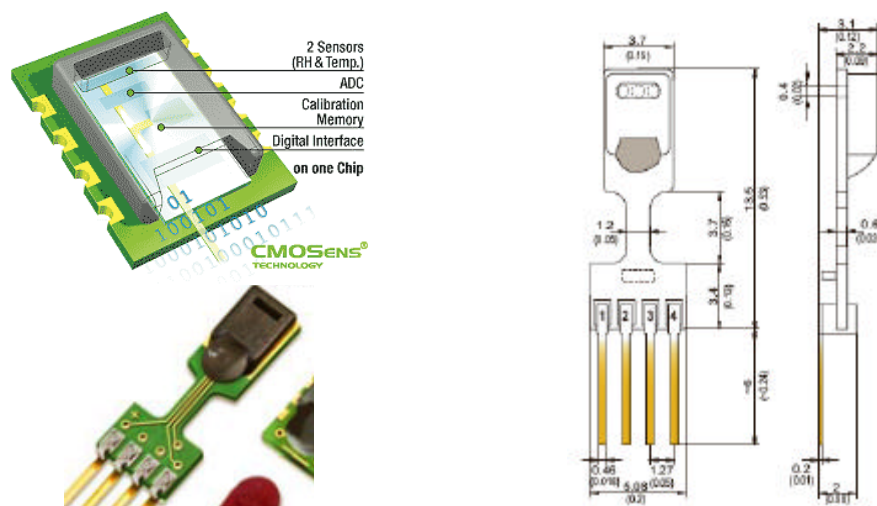

**Figure 4-3: Sensirion SHT75 transmitters: description and dimensions.**

[PEBS]

D2.3-1: Feasibility report on GAME mock-ups & D2.3-2.1: Reports on GAME status, 1<sup>st</sup> report

Dissemination level: PU

Date of issue of this report: December 2011

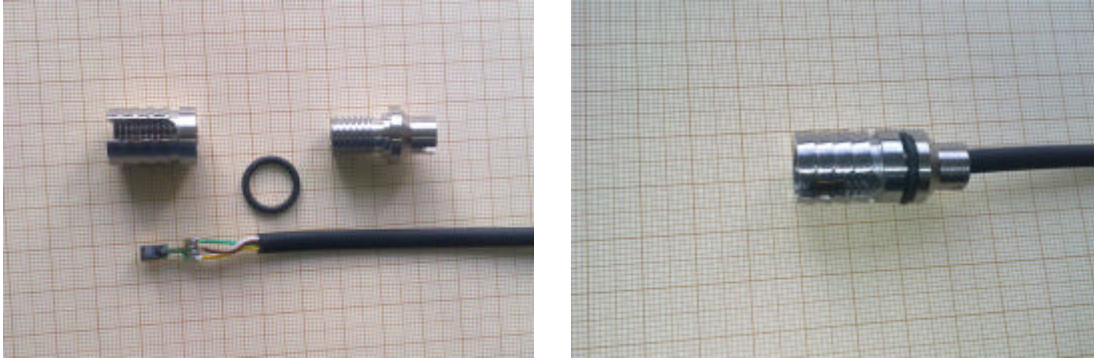
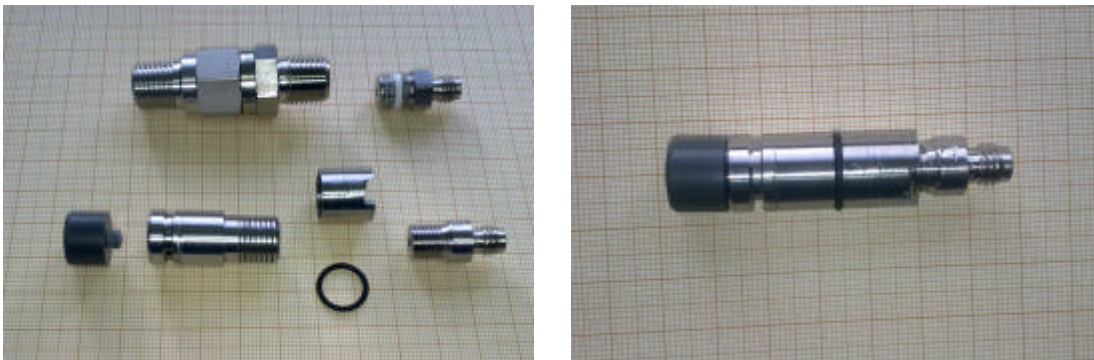

**Figure 4-4: New support for RH-T transmitters: parts and assembly.**

Sensors are sealed with epoxy adhesives EPOTEK 730 and 509-EBT-M (Epoxy Technology, 2001 and 2003). The cables exit the electrode probes and are connected to the electronics.

### **Water sampling port**

New sampling ports, closed by modified SWAGELOK check-valves (Figure 4-5), have been installed. The port/rod sealing is achieved by o-rings. The check-valve is activated by inserting a modified SWAGWLOK cup.



**Figure 4-5: New water sampling port: original/modified parts and assembly.**

### **I/O of the structure**

After installation of the sensors and sampling port, some leakages were observed in several insertions, so additional seals were installed in all the insertions.

These seals are composed of several silicone plugs (with different lengths), screw-compressed to fix against the wall of the insertion. In some cases, commercial screw plugs were installed in the outer part of the drill.

Finally, the whole set of plugs and tubes was fixed to the structure to prevent their displacement and the polyamide tubes were interconnected (Figure 4-6).

---

[PEBS]

D2.3-1: [Feasibility report on GAME mock-ups](#) & D2.3-2.1: [Reports on GAME status, 1<sup>st</sup> report](#)

Dissemination level: PU

Date of issue of this report: **December 2011**



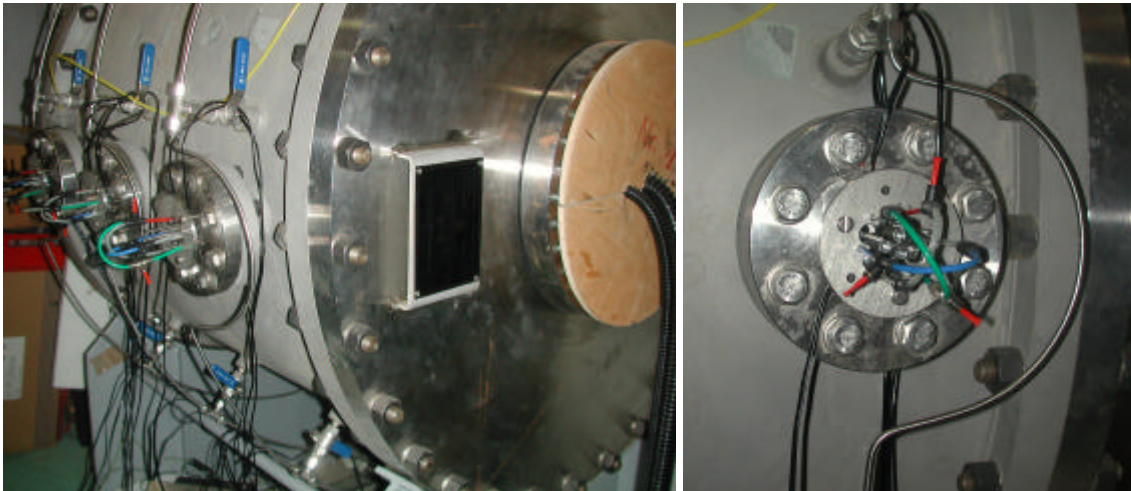

**Figure 4-6: Final I/O in the structure: detail.**

### 4.3 Installation of DAS

The main modifications in the hardware components of the DAS have been the elimination of the data-loggers, so the 19"-racks for the DAS electronics (including the HCS) appears as shown in Figure 4-7.

	<b>Control PC + Ethernet hub</b>
	<b>NI Ethernet serial server (x 2)</b>
	<b>Druck DPI520 pressure controller (x2)</b>
	<b>HBM 250DV Amplifier (x 2)</b>
	<b>West MLC9000+ controller Solid state relays +Thermal protections</b>
	<b>220 to 24 VAC 4 converters (x 2)</b>

**Figure 4-7: New view and description of the DAS 19"-rack**

[PEBS]

D2.3-1: [Feasibility report on GAME mock-ups](#) & D2.3-2.1: [Reports on GAME status, 1<sup>st</sup> report](#)

Dissemination level: PU

Date of issue of this report: **December 2011**

## 5 OPERATION AND RESULTS

In the following descriptions, there are two phases of the tests. The first phase corresponds to the NF-PRO project, from July 06' to June 07', and the second phase corresponds to the PEBS project, from March 10' to October 11'. To prevent mistakes, each phase has its own zero reference time (July 1<sup>st</sup> 06', at 14:00 hours and March 1<sup>st</sup> 10' at 14:00 hours, respectively) and its own graphic template.

Some operations were performed in the experiment before the start-up to assure the boundary conditions of the experiment, both thermal (heater's temperature) and hydraulic (injection pressure and water volume).

Between both phases, from May 07' (when it was decided to stop the NF-PRO experiments) to June 09' (the beginning of verifications associated to the future PEBS), there are no data available.

The figures correspond to the data from the beginning of each phase.

### 5.1 Hydration

The hydration process is described by the phases corresponding to the previous project, NF-PRO, and the PEBS project.

#### 5.1.1 NF-PRO phase

After testing that both structures were gastight (by injection of nitrogen at 0.15 MPa) and the piping networks were watertight (by pressurising the system with nitrogen at 1.0 MPa), the injection of water began.

#### **Test S1**

The initial mass of water in the tank was 186.7 kg at 05/07/06 (day 5; Figure 5-1). From this time, a first injection of water was made to flood the barrier system and prevent the formation of preferential pathways of hydration between blocks by the swelling of the bentonite, but a leakage was observed in the joint between the cover and the heating core. An injection pressure-controller fixed the nominal value of pressure at 0.9 MPa. Hydration was stopped after injecting 42.4 kg.

After this mishap, the actions to correct the problem were taken, but it took a large time to solve the leakage due to the position of the joint. Several injections were made afterwards in order to control the possible leakage in the long term, and to prevent the hydration system from wasting the reduced natural groundwater from GTS (Switzerland). The sequence of injections is shown in Figure 5-1 and Table 5.1.

The main injections were made during the first months to a total mass of water injected of 80.8 kg at 28/07/06. Then a large period of tests to stop the small leakages observed in some electrode rods made us to reduce the injection of water to small pulses. The complete series of injections is shown in Table 5.1 and it finished in May 07'. From this date, the hydration was stopped but the injection water in the structure was not purged.

No variations were observed during injections in the temperature, but pH increased slowly between days 120 to 177 and remained almost constant from day 200.

---

[PEBS]

D2.3-1: [Feasibility report on GAME mock-ups](#) & D2.3-2.1: [Reports on GAME status, 1<sup>st</sup> report](#)

Dissemination level: PU

Date of issue of this report: **December 2011**

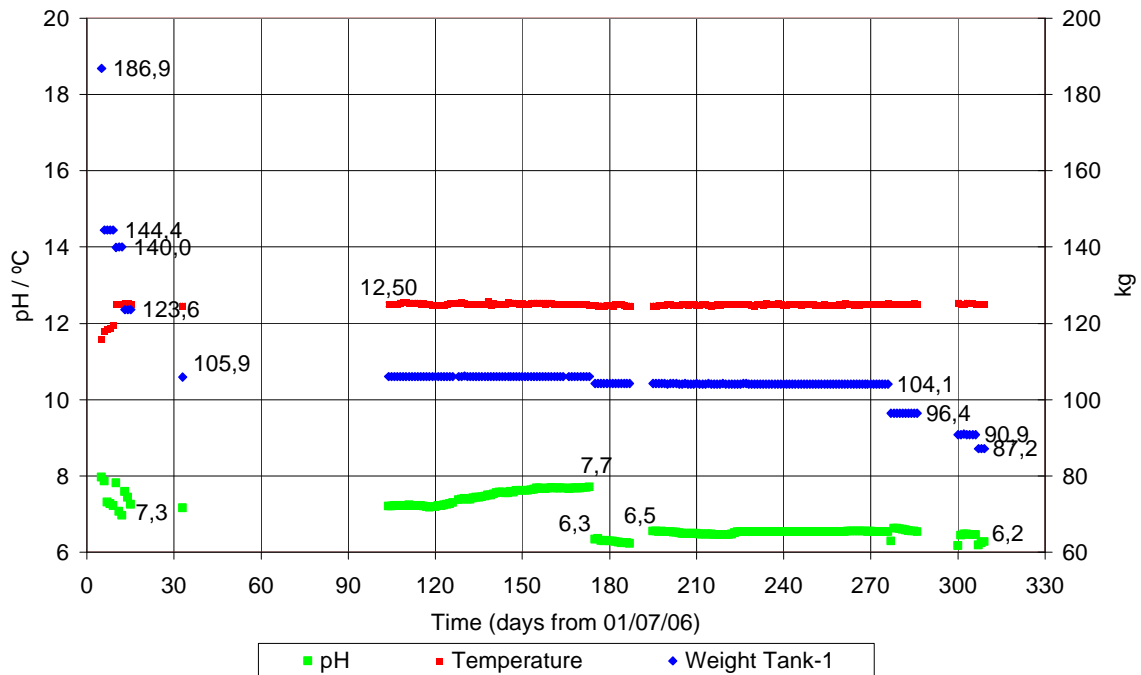

**Figure 5-1: Mass of water, pH and temperature: initial phase, test S1.**

**Table 5.1: Series of injections of water: initial phase, test S1.**

DATE	Time (days)	Tank Weight (kg)	Total mass of water (kg)
05/06/2006	5	<b>186.7</b>	
07/07/2006	7	144.3	42.4
11/07/2006	10	139.9	46.8
20/07/2006	20	123.6	63.1
21/07/2006	21	113.0	73.7
28/07/2006	28	105.9	80.8
22/12/2006	174	104.3	82.4
04/04/2007	277	96.5	90.2
27/04/2007	300	90.9	95.8
03/05/2007	306	87.1	99.6

### **Test S2**

The initial mass of water in the tank was 205.4 kg at 05/07/06 (day 5; Figure 5-1). From this time, a first injection of water was made to flood the barrier system and prevent the formation of preferential pathways of hydration between blocks by the swelling of the bentonite, but two leakages were observed: one small in the joint between the cover and the heating core, and another one bigger in the flange of rod B. An injection pressure-controller fixed the nominal value of pressure at 0.9 MPa. Hydration was stopped after injecting 42.4 kg.

After this mishap, the actions to correct the problem were taken, but it took a large time to solve the small leakage due to the position of the joint. In the case of the flange, it was necessary to extract the rod to modify the sealing joints. Several injections were made afterwards in order to control the possible leakage in the long term, and to prevent the hydration system from wasting the saline water. The sequence of injections is shown in Figure 5-2 and Table 5-2.

[PEBS]

D2.3-1: [Feasibility report on GAME mock-ups](#) & D2.3-2.1: [Reports on GAME status, 1<sup>st</sup> report](#)

Dissemination level: PU

Date of issue of this report: **December 2011**

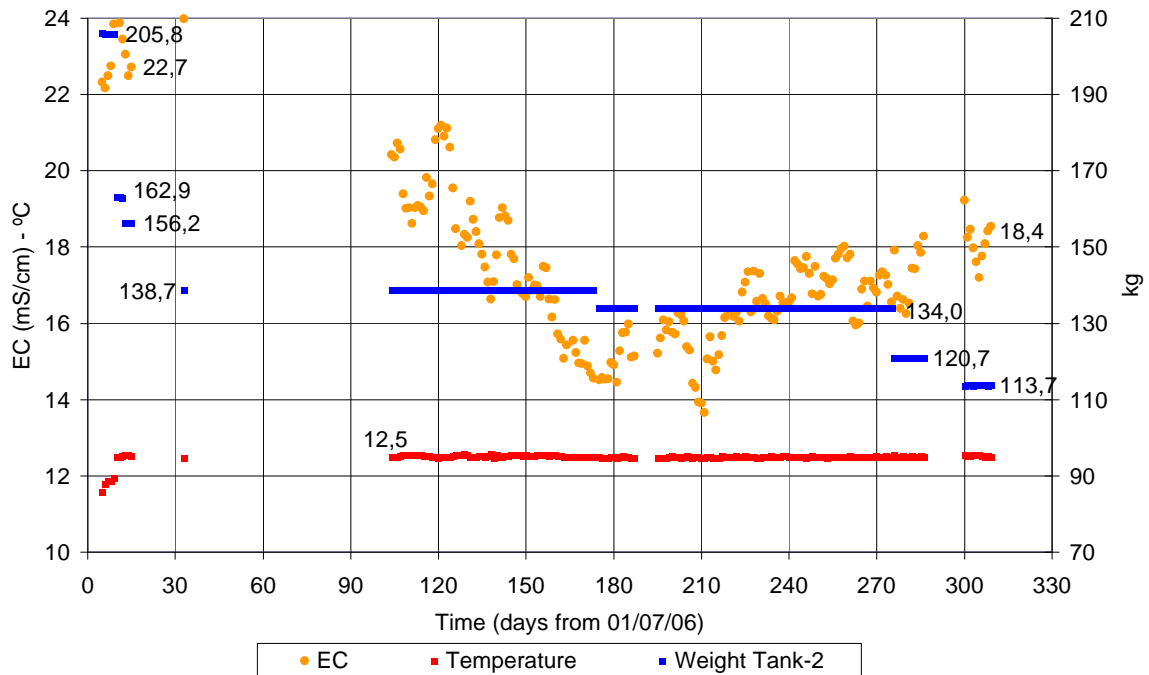

**Figure 5-2: Mass of water, EC and temperature: initial phase, test S2.**

The main injections to date were made during the first month to a total mass of 66.7 kg at 28/07/06. Then a large period of tests to stop the small leakages observed in some electrode rods made us to reduce the injection of water to small pulses. As in test S1, the injections finished in May 07' and, from this date, the hydration was stopped but the injection water in the structure was not purged. The complete series of injections is shown in Table 5-2.

**Table 5-2: Series of injections of water: initial phase, test S2.**

DATE	Time (days)	Tank Weight (kg)	Total mass of water (kg)
05/06/2006	5	<b>205.4</b>	
07/07/2006	7	205.4	0.0
11/07/2006	10	163.0	42.4
20/07/2006	20	156.2	49.2
21/07/2006	21	145.2	60.2
28/07/2006	28	138.7	66.7
22/12/2006	174	134.0	71.4
03/04/2007	277	120.8	84.6
17/04/2007	300	113.9	91.5

No variations were observed during injections in the temperature, but EC decreased during first 180 days and then increased slowly.

[PEBS]

D2.3-1: Feasibility report on GAME mock-ups & D2.3-2.1: Reports on GAME status, 1<sup>st</sup> report

Dissemination level: PU

Date of issue of this report: December 2011

## 5.1.2 PEBS phase

### Test S1

The initial mass of water in the tank was 87.00 kg at 23/02/10 (day -7; Figure 5-3). At this time, a first injection of water was made before any modification in the system, but new leakages were observed. Hydration was stopped after injecting 4.64 kg.

After the major modifications (turning of the structure and changes in the instrumentation ports), other injections were made from June 11' to October 11' but slight leakages have also been observed (Table 5.3; Figure 5-3). From November 11', the hydration was stopped but the injection water in the structure was not purged.

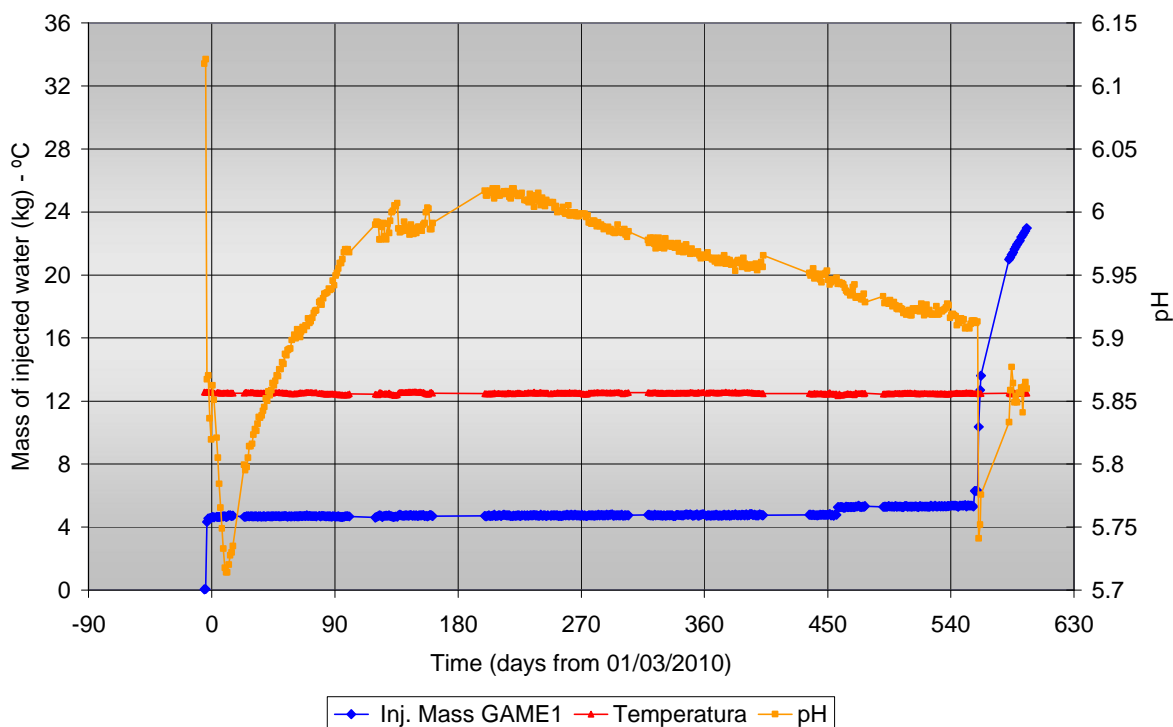

**Figure 5-3: Test S1 hydration: injected water, pH and temperature.**

**Table 5.3: Series of injections of water: test S1.**

DATE	Time (days)	Tank Weight (kg)	Total mass of water (kg)
23/02/2010	-5	<b>87.0</b>	
01/03/2010	0	82.4	4.6
01/06/2011	457	81.8	5.2
09/09/2011	557	80.8	6.2
12/09/2011	560	76.7	10.4
13/09/2011	561	74.4	12.6
14/09/2011	562	73.5	13.5
04/10/2011	582	66.1	20.9

As in the previous phase, no variations were observed during injections in the temperature but the pH values seem to be related with the water movement in the hydration line (first movement produced a sharp decreasing, days 0 and 560, to be re-equilibrated). Values observed are in the range of those in the previous phase.

[PEBS]

D2.3-1: [Feasibility report on GAME mock-ups](#) & D2.3-2.1: [Reports on GAME status, 1<sup>st</sup> report](#)

Dissemination level: PU

Date of issue of this report: **December 2011**



## Test S2

The initial mass of water was 113.6 kg at 23/02/10 (day -7; Figure 5-4). At this time, as in test S1, a first injection of water was made, but leakages were observed. Hydration was stopped after injecting 7.3 kg.

After the major modifications, new injections were made from June 11' to September 11' but massive leakages were observed (related to the steps, Table 5.4; Figure 5-4). From this date, the hydration was stopped but the injection water in the structure was not purged.

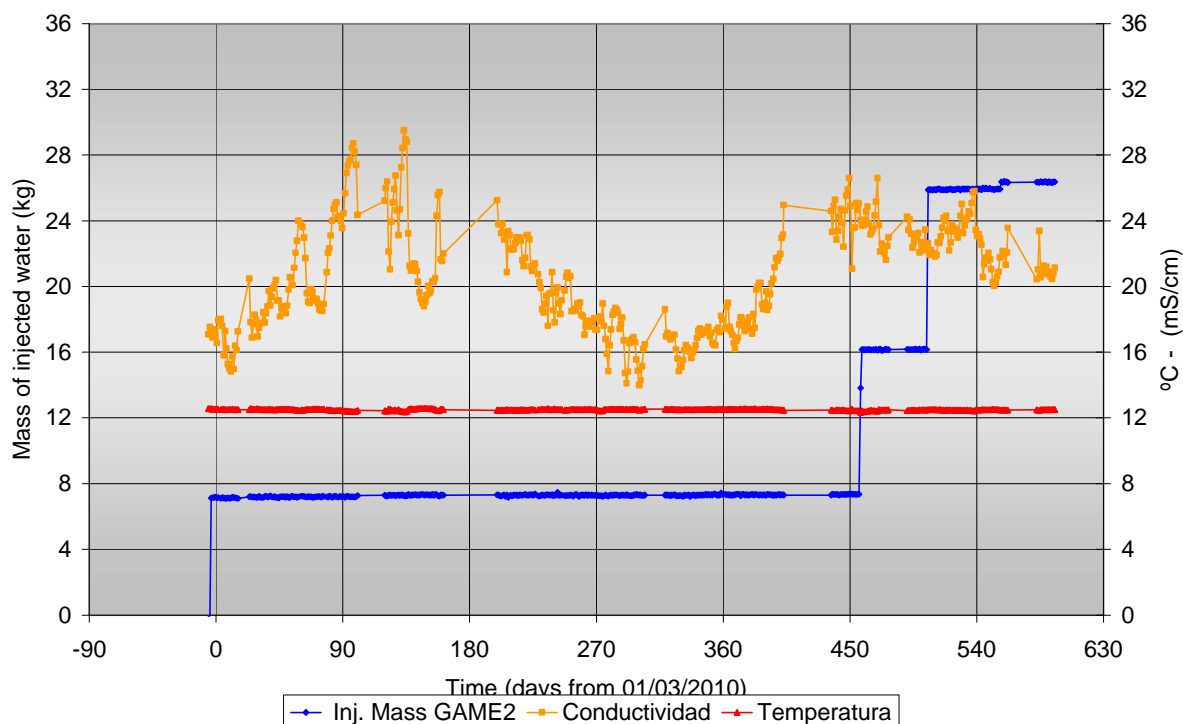

Figure 5-4: Test S2 hydration: injected water, EC and temperature.

Table 5.4: Series of injections of water: test S2.

DATE	Time (days)	Tank Weight (kg)	Total mass of water (kg)
23/02/2010	-5	<b>113.6</b>	
01/03/2010	0	106.3	7.3
01/06/2011	457	99.6	14.0
02/06/2011	458	97.3	16.3
19/07/2011	505	87.6	26.0
09/09/2011	557	87.1	26.5

Conductivity values seem to follow a seasonal wave to be confirmed, but not affected during injections. Values observed are in the range of those in the previous phase.

## 5.2 Heating

The power supply to the heater systems was checked before beginning the operational phase, by heating at low power to prevent the bentonite from changing its moisture content.

[PEBS]

D2.3-1: Feasibility report on GAME mock-ups & D2.3-2.1: Reports on GAME status, 1<sup>st</sup> report

Dissemination level: PU

Date of issue of this report: December 2011

### 5.2.1 NF-PRO phase

Heating was delayed due to the observed leakages in the structure. The first heating phase started on day 104 with low temperature to study the behaviour of the system. After a few days, the target temperatures in the different zones of heating were fixed in 35, 33 y 31°C for the two central zones, the four intermediate zones, and the two lateral zones, respectively. The target temperature in the two lateral zones was decreased to 30°C to prevent the system from an excessive thermal waste. These targets were operative till the end of the phase, May 07'.

#### Test S1

As shown in Figure 5-5, the systems fixed the target temperatures of the test.

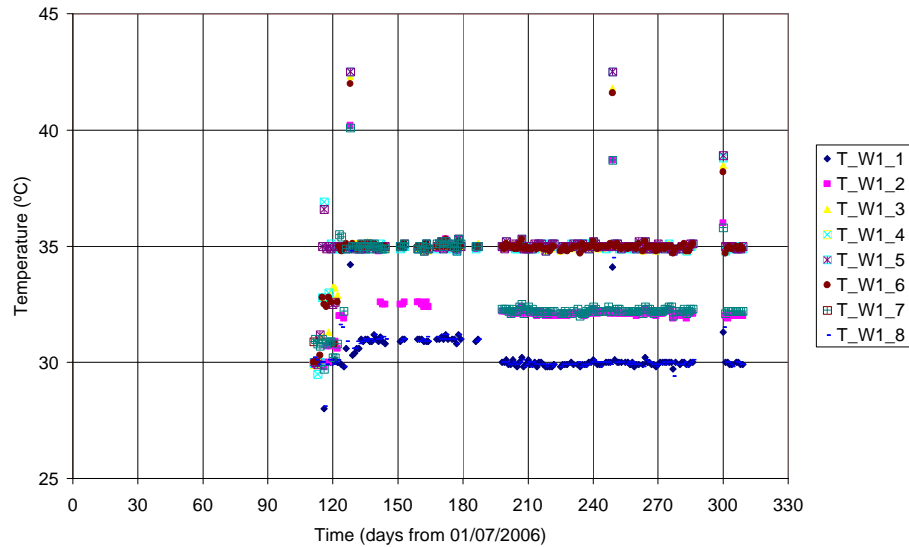

**Figure 5-5: Heater temperatures from the controller: initial phase, test S1.**

#### Test S2

As shown in Figure 5-6, the systems fixed the target temperatures of the test.

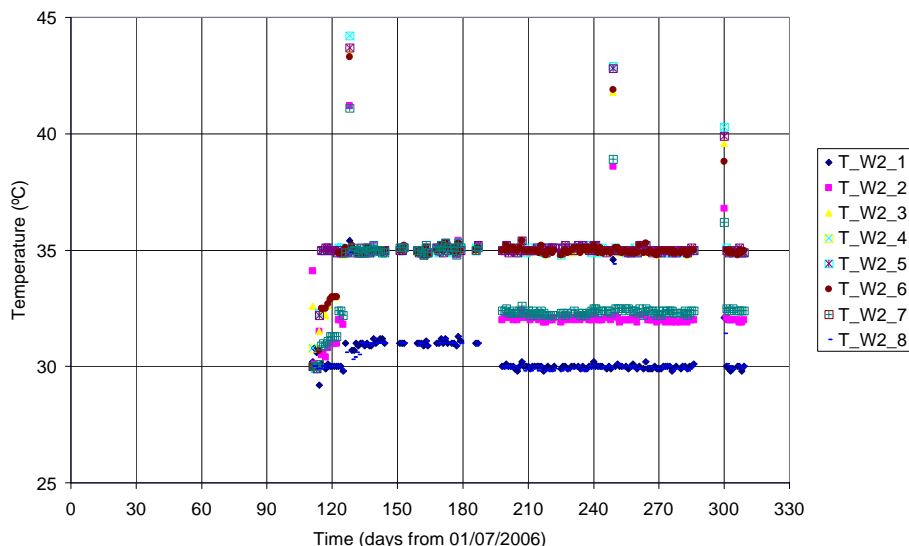

**Figure 5-6: Heater temperatures from the controller: initial phase, test S2.**

[PEBS]

D2.3-1: Feasibility report on GAME mock-ups & D2.3-2.1: Reports on GAME status, 1<sup>st</sup> report

Dissemination level: PU

Date of issue of this report: December 2011

### 5.2.2 PEBS phase

Heating has been active at low temperature, with target temperatures of 25°C in all heating zones, from June 09', before the beginning of the project. These targets were changed to 26°C, low enough to prevent the thermally-induced movement of water inside the barrier, but high enough to manage the operation of the heaters.

Two types of behaviour have been observed in both experiments: first, some period of apparent anomalous function of the heaters (Figure 5-7 and Figure 5-9) can be attributed to external temperatures so high that induced heater temperatures higher than the target ones; second, the lose of data transmission has not affected the operation of the heating control (Figure 5-8 and Figure 5-10).

It is expected than higher target temperatures as in the previous phase will prevent this anomalous behaviour.

## 5.3 TH behaviour

The readings from the sensors within the bentonite are presented arranged by instrumentation rods, in a consecutive way from rod A to rod E. The sensors are plotted by measured parameters (temperature and RH). Similar plots have the same ordinate axis to facilitate the comparison.

Temperature and relative humidity are measured with the SENSIRION digital transmitters. A problem to be noted is that when temperature transmitter fails, it sends a value of -42°C. This characteristic produces zero values in RH (calculated from temperature).

### 5.3.1 NF-PRO phase

The figures (Martín & Barcala, 2007 c-d) corresponding to both test, have been grouped to make easier the comparison: Figure 5-11 to Figure 5-15 (test S1) and Figure 5-16 to Figure 5-20 (test S2).

From these figures it is clear that the damage of the sensors is lower in test S1 but the reason is not so evident. Several factors could explain this fact: the different type of water and chemical processes involved, the effect of the alkaline plume generated by the concrete, or some kind of failure in the installation of the rods.

Related to the RH measures, it is shown in test S1 that after the beginning of heating, considering that hydration was stopped, a redistribution of internal water occurred. Sensors in all rods showed the initial increase due to the heating and the subsequent thermally-induced drying (very slight due to the low temperatures; Figure 5-11 to Figure 5-20, top). This behaviour of the RH sensors is only altered by the injection events on days 190, 280 and 300, which increased their values and even in some cases have induced an opposite effect (probably due to malfunction; Figure 5-14 to Figure 5-15, top ).

At the end of this phase, the values of most of the RH sensors, after measuring values in the 80-90% range or higher, indicated some type of water redistribution inside the barrier afterwards the hydration was stopped (Figure 5-19 and Figure 5-20; top), with values as low as 40% in test S2.

With respect to temperature, it is shown in both tests, but more clearly in test S1, that its distribution is homogeneous, in spite of the small waves observed. The higher temperatures are recorded by the sensors close to the heater and the lower temperatures close to the structure (Figure 5-11 to Figure 5-20, bottom). Two of the injection events (days 190 and 300) induced a sharp and brief decrease of temperature values, probably associated to the arrival of cold water.

---

[PEBS]

D2.3-1: [Feasibility report on GAME mock-ups](#) & D2.3-2.1: [Reports on GAME status, 1<sup>st</sup> report](#)

Dissemination level: PU

Date of issue of this report: **December 2011**

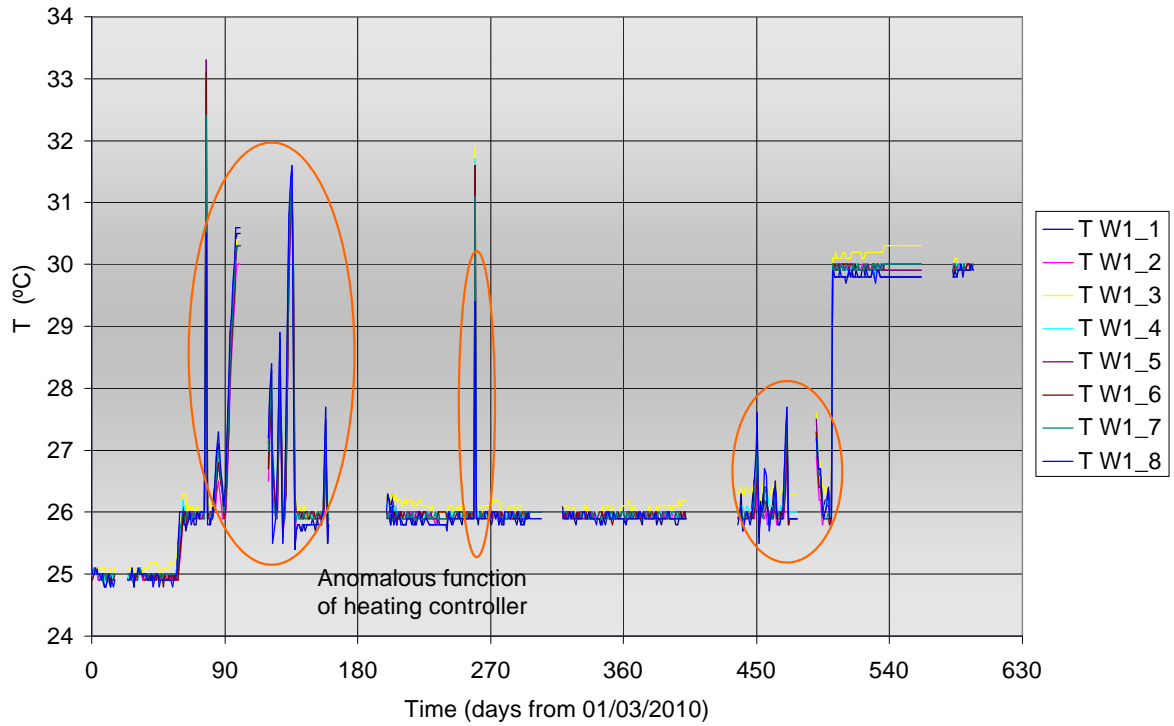

**Figure 5-7: Heater temperatures from the controller: test S1**

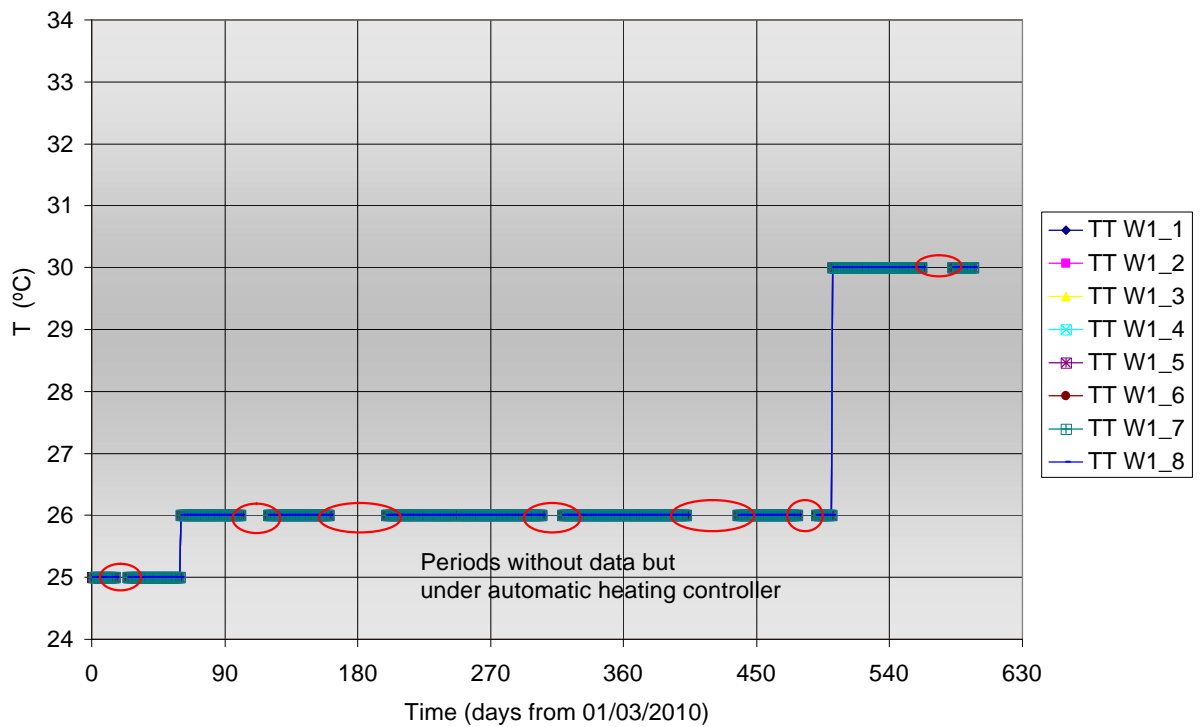

**Figure 5-8: Target temperatures from the controller: test S1**

[PEBS]

D2.3-1: Feasibility report on GAME mock-ups & D2.3-2.1: Reports on GAME status, 1<sup>st</sup> report

Dissemination level: PU

Date of issue of this report: December 2011

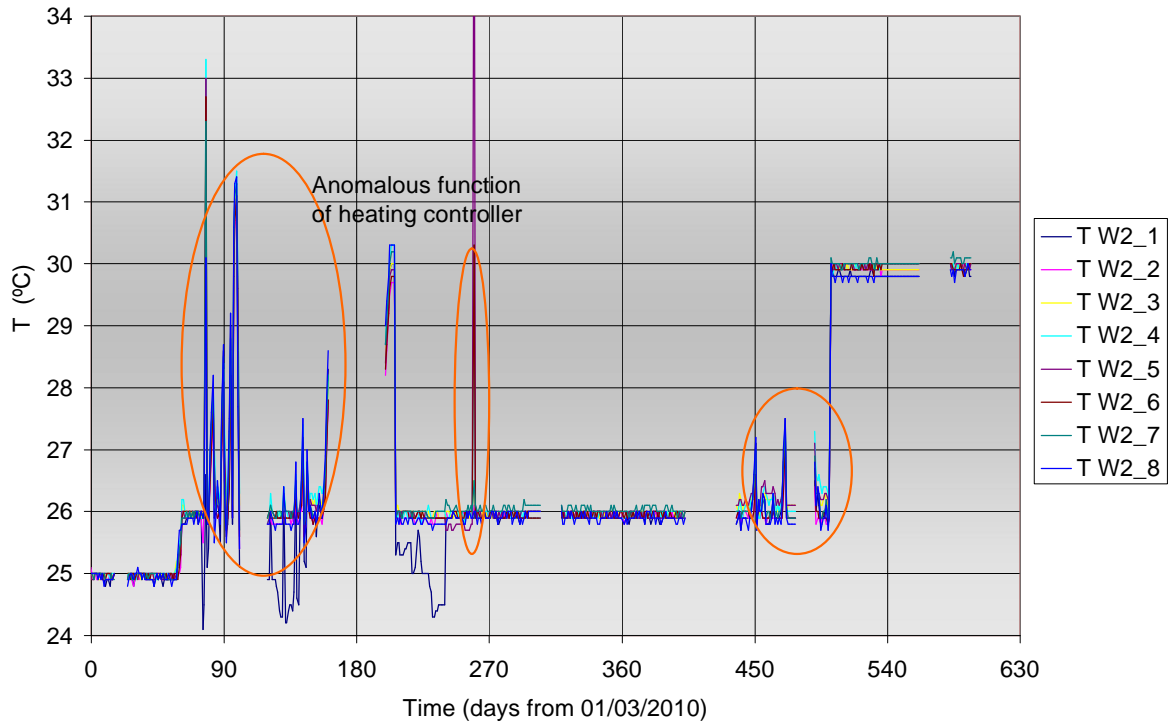

**Figure 5-9: Heater temperatures from the controller: test S2**

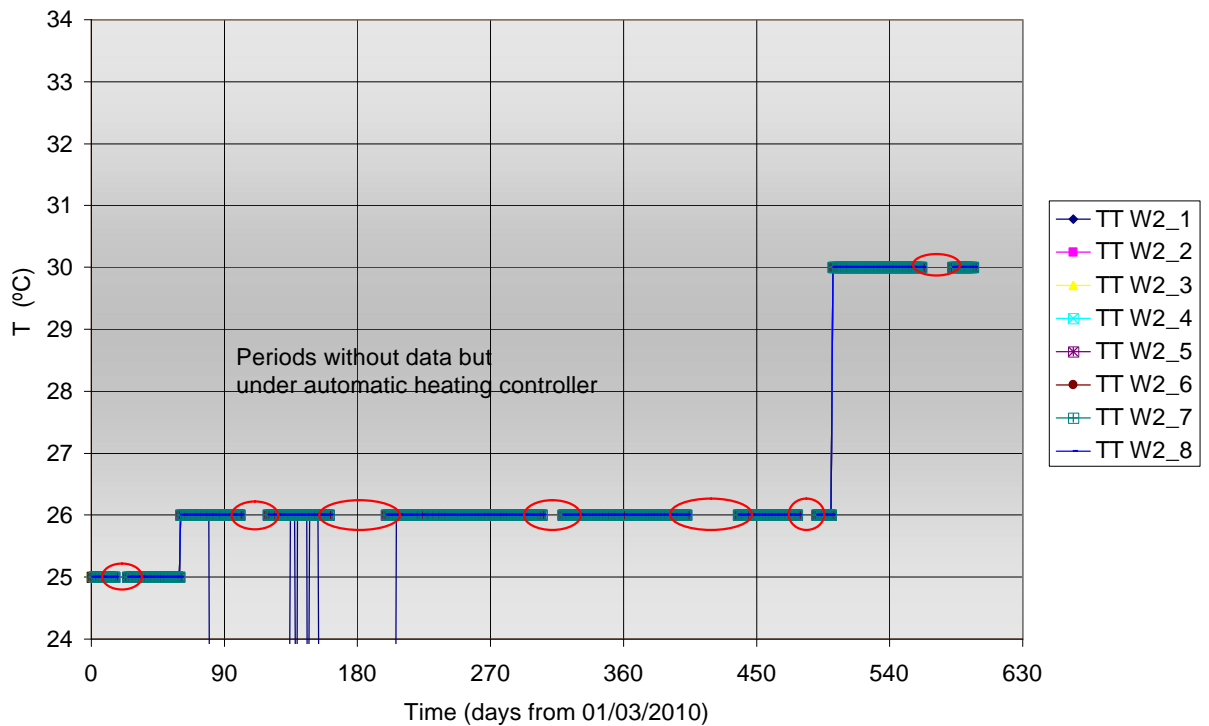

**Figure 5-10: Target temperatures from the controller: test S2.**

[PEBS]

D2.3-1: Feasibility report on GAME mock-ups & D2.3-2.1: Reports on GAME status, 1<sup>st</sup> report

Dissemination level: PU

Date of issue of this report: December 2011



## Test S1

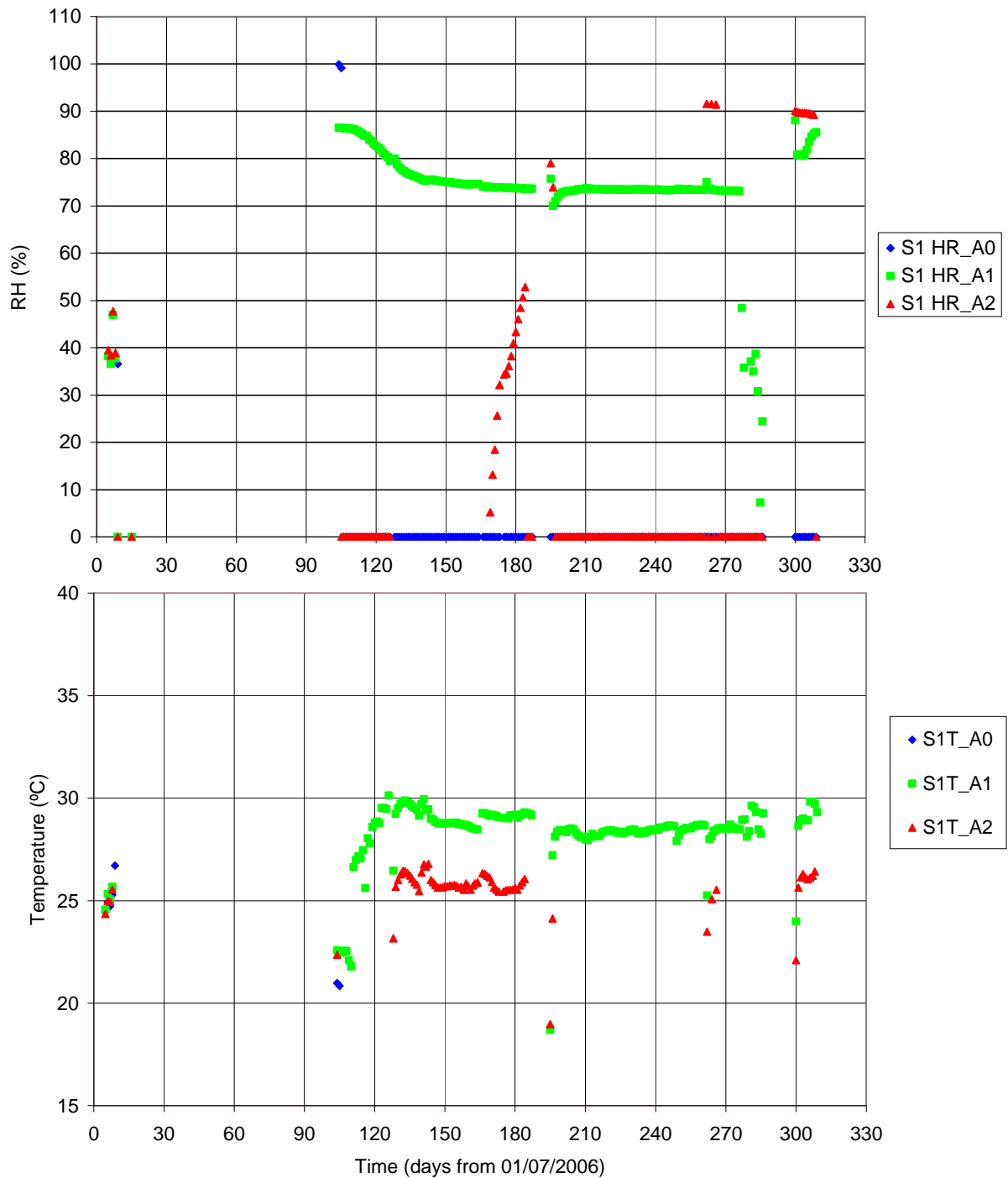

**Figure 5-11: Test S1 NF-PRO phase: RH and T values from rod A: sensors A0, A1, A2 located at coordinates (X= -0.3; Y= 0.395, 0.315, 0.225, respectively).**

[PEBS]

D2.3-1: [Feasibility report on GAME mock-ups](#) & D2.3-2.1: [Reports on GAME status, 1<sup>st</sup> report](#)

Dissemination level: PU

Date of issue of this report: **December 2011**

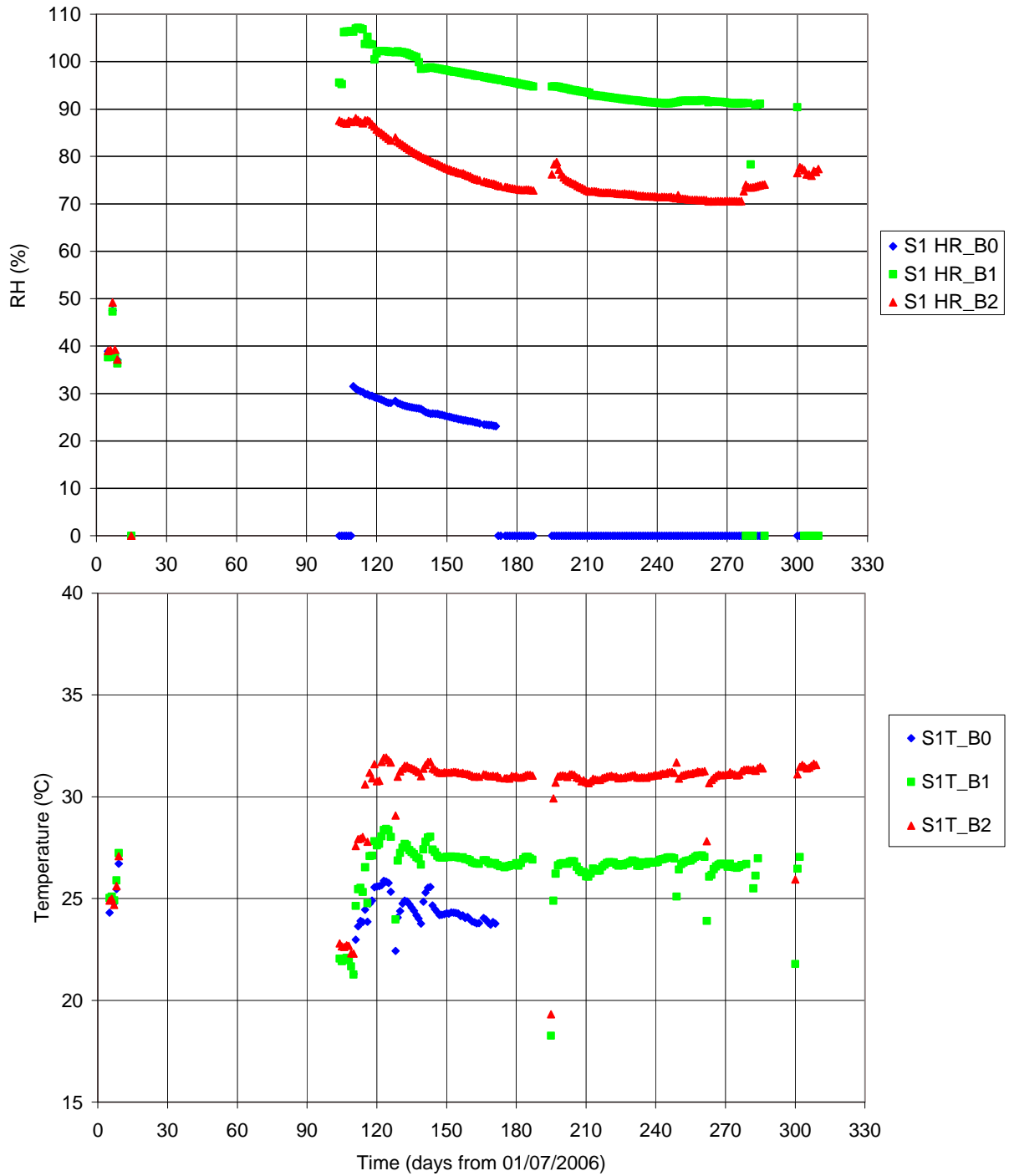

**Figure 5-12: Test S1 NF-PRO phase: RH and T values from rod B: sensors B0, B1, B2 located at coordinates (X= 0.0; Y= 0.405, 0.295, 0.205, respectively).**

[PEBS]

D2.3-1: [Feasibility report on GAME mock-ups](#) & D2.3-2.1: [Reports on GAME status, 1<sup>st</sup> report](#)

Dissemination level: PU

Date of issue of this report: **December 2011**

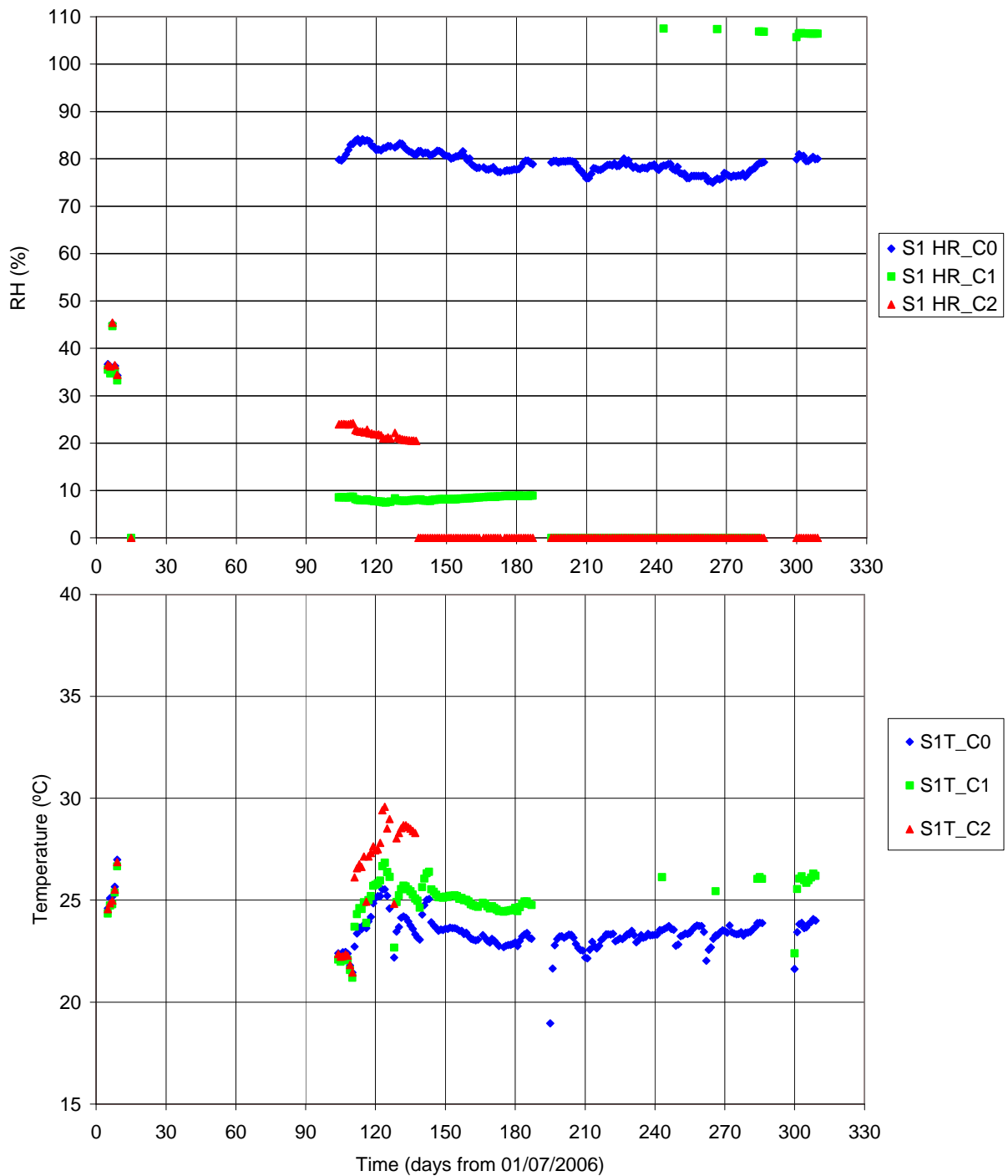

**Figure 5-13: Test S1 NF-PRO phase: RH and T values from rod C: sensors C0, C1, C2 located at coordinates (X= 0.3; Y= 0.425, 0.335, 0.245, respectively).**

[PEBS]

D2.3-1: Feasibility report on GAME mock-ups & D2.3-2.1: Reports on GAME status, 1<sup>st</sup> report

Dissemination level: PU

Date of issue of this report: December 2011

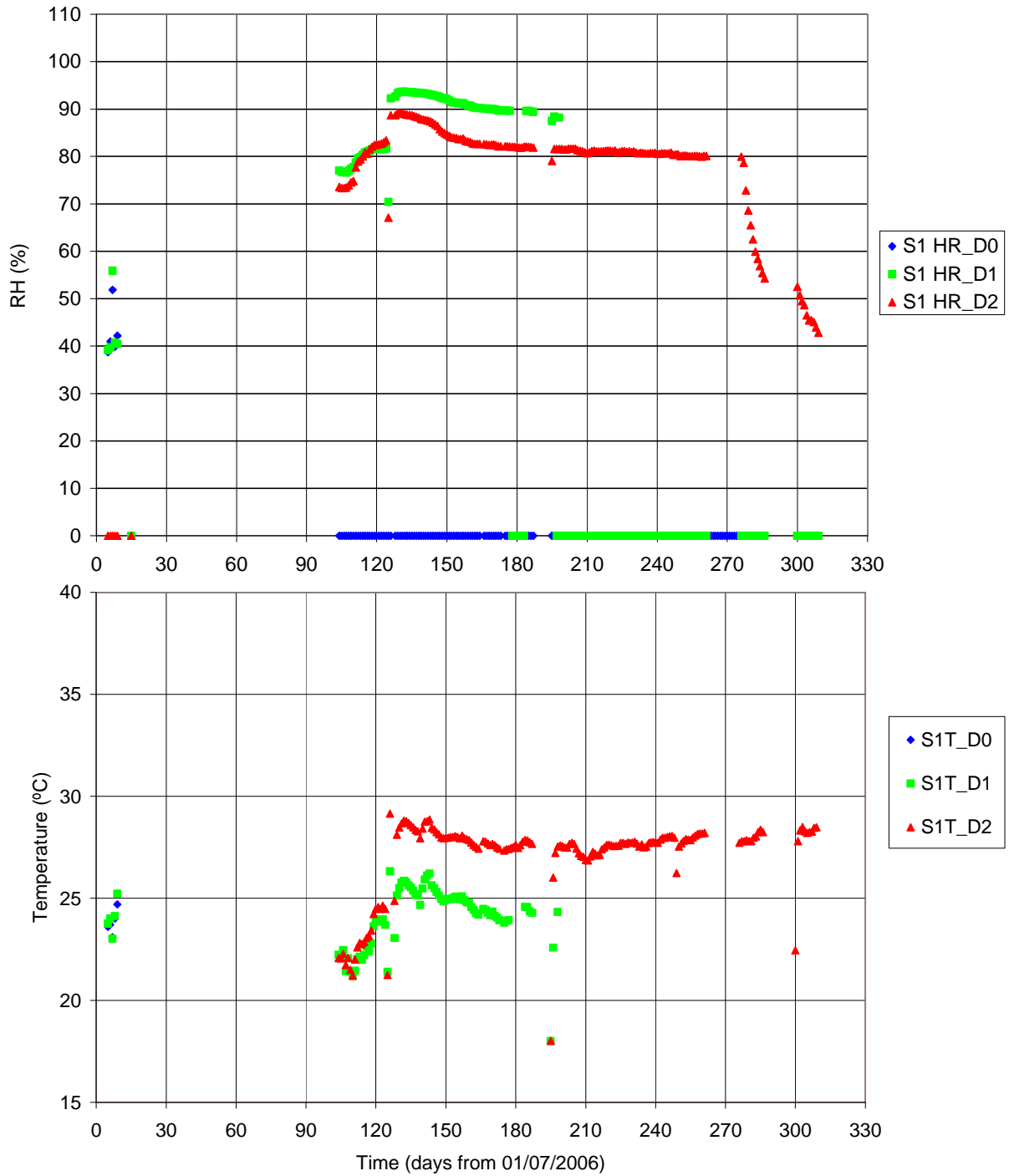

**Figure 5-14: Test S1 NF-PRO phase: RH and T values from rod D: sensors D0, D1, D2 located at coordinates (X= -0.15; Y= 0.445, 0.355, 0.265, respectively).**

[PEBS]

D2.3-1: [Feasibility report on GAME mock-ups](#) & D2.3-2.1: [Reports on GAME status, 1<sup>st</sup> report](#)

Dissemination level: PU

Date of issue of this report: **December 2011**

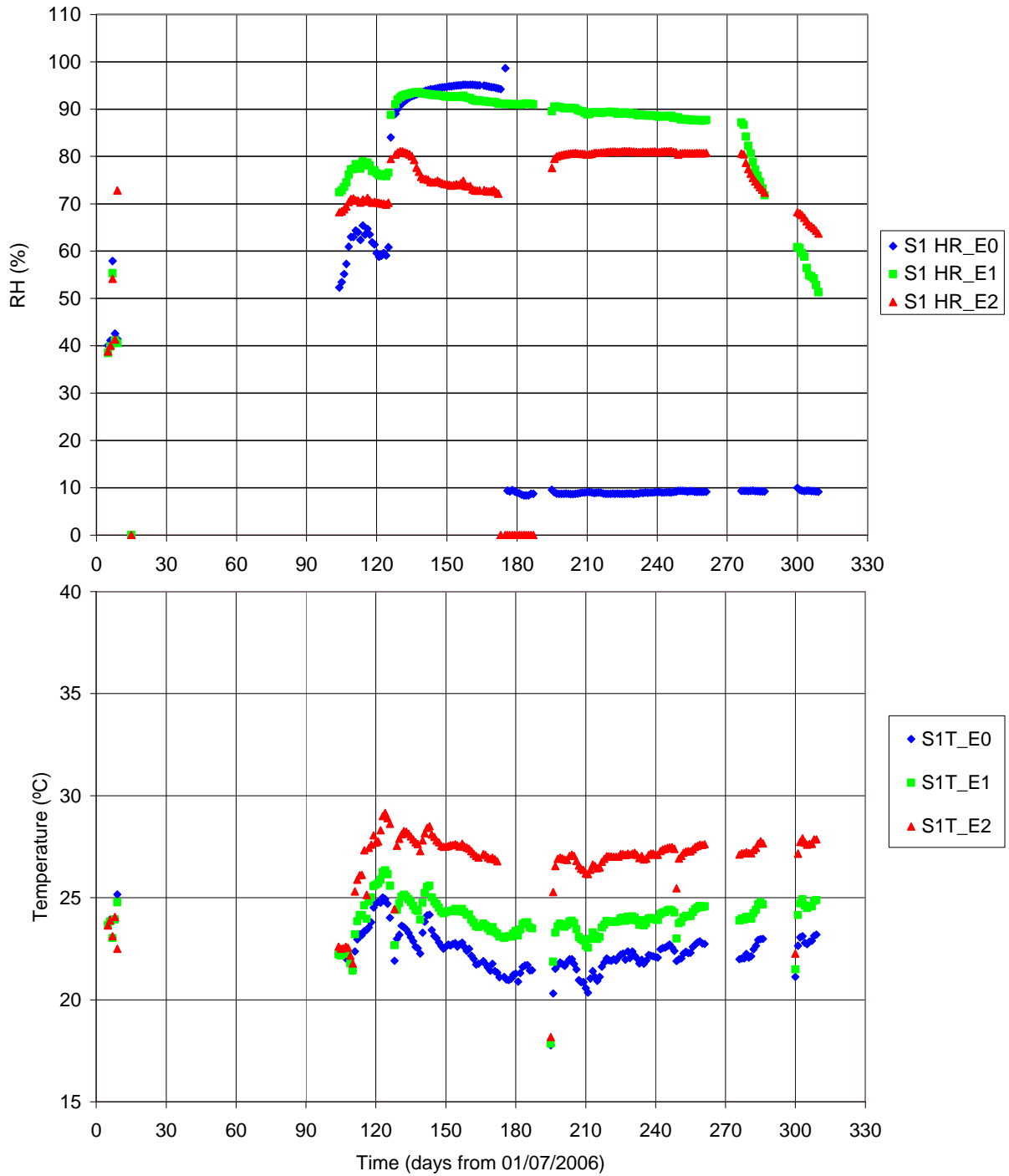

**Figure 5-15: Test S1 NF-PRO phase: RH and T values from rod E: sensors E0, E1, E2 located at coordinates (X= 0.3; Y= 0.465, 0.375, 0.285, respectively).**

[PEBS]

D2.3-1: [Feasibility report on GAME mock-ups](#) & D2.3-2.1: [Reports on GAME status, 1<sup>st</sup> report](#)

Dissemination level: PU

Date of issue of this report: **December 2011**



## Test S2

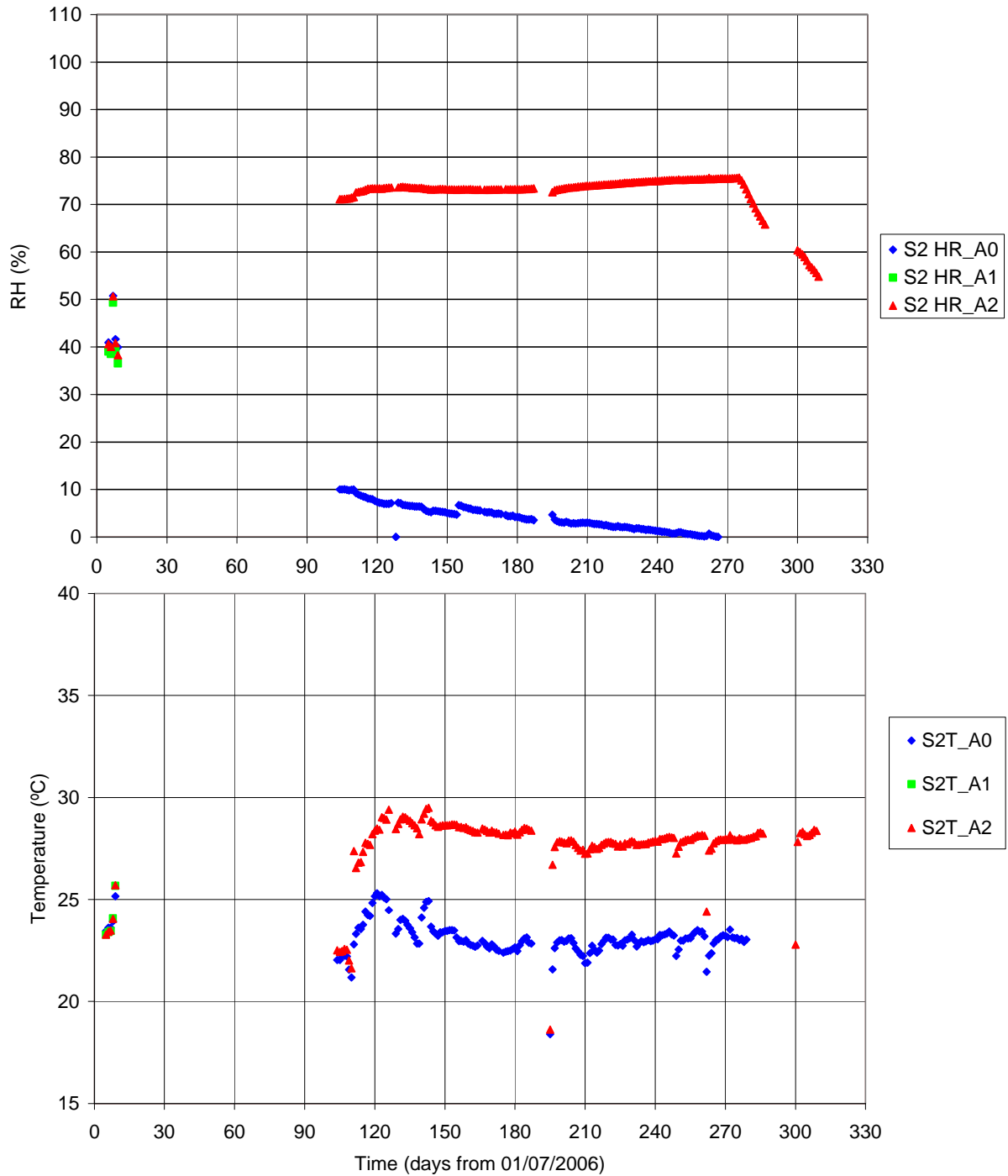

**Figure 5-16: Test S2 NF-PRO phase: RH and T values from rod A: sensors A0, A1, A2 located at coordinates (X= - 0.3; Y= 0.395, 0.315, 0.225, respectively).**

[PEBS]

D2.3-1: Feasibility report on GAME mock-ups & D2.3-2.1: Reports on GAME status, 1<sup>st</sup> report

Dissemination level: PU

Date of issue of this report: December 2011

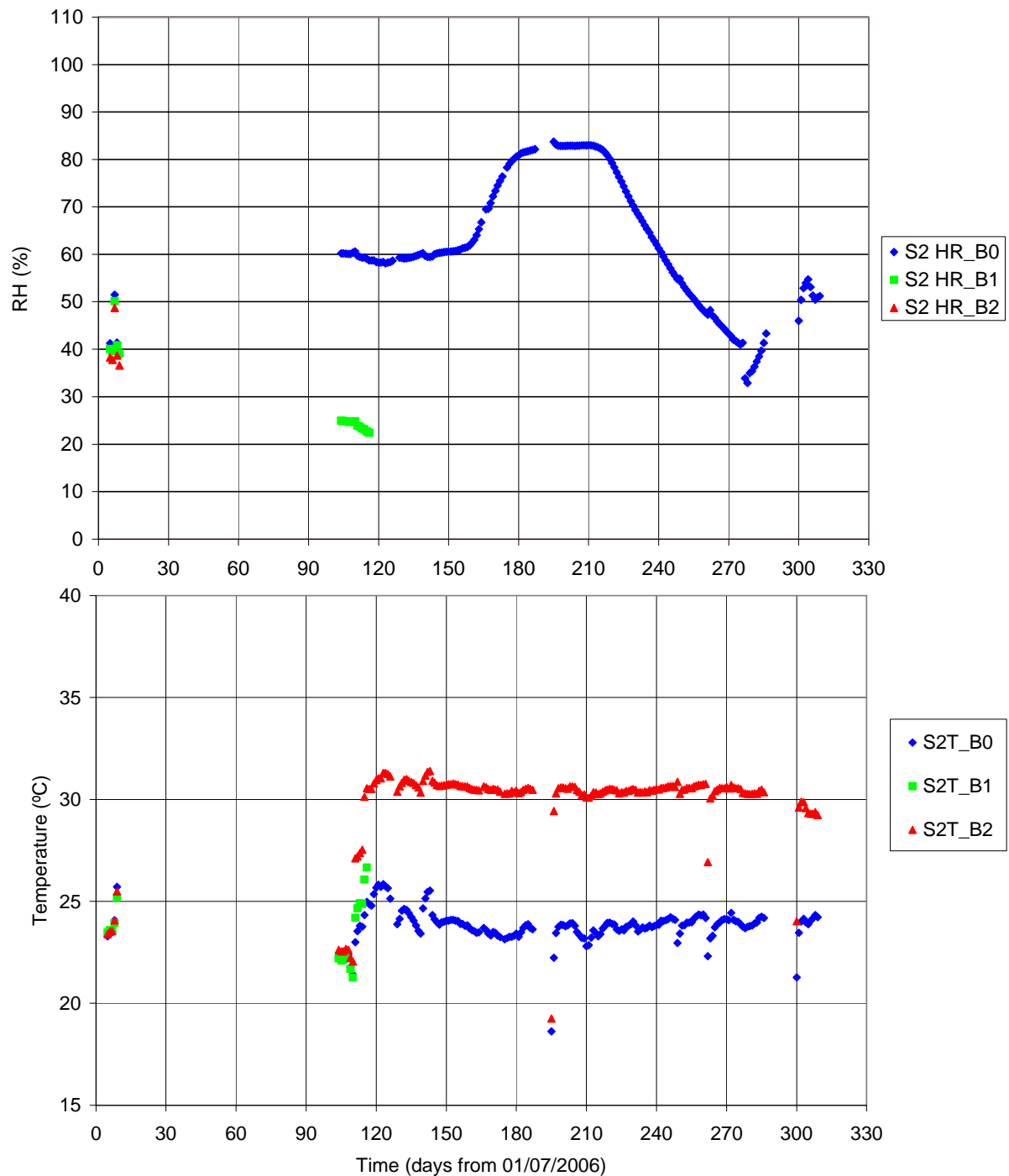

**Figure 5-17: Test S2 NF-PRO phase: RH and T values from rod B: sensors B0, B1, B2 located at coordinates (X= 0.0; Y= 0.405, 0.295, 0.205, respectively).**

[PEBS]

D2.3-1: Feasibility report on GAME mock-ups & D2.3-2.1: Reports on GAME status, 1<sup>st</sup> report

Dissemination level: PU

Date of issue of this report: December 2011

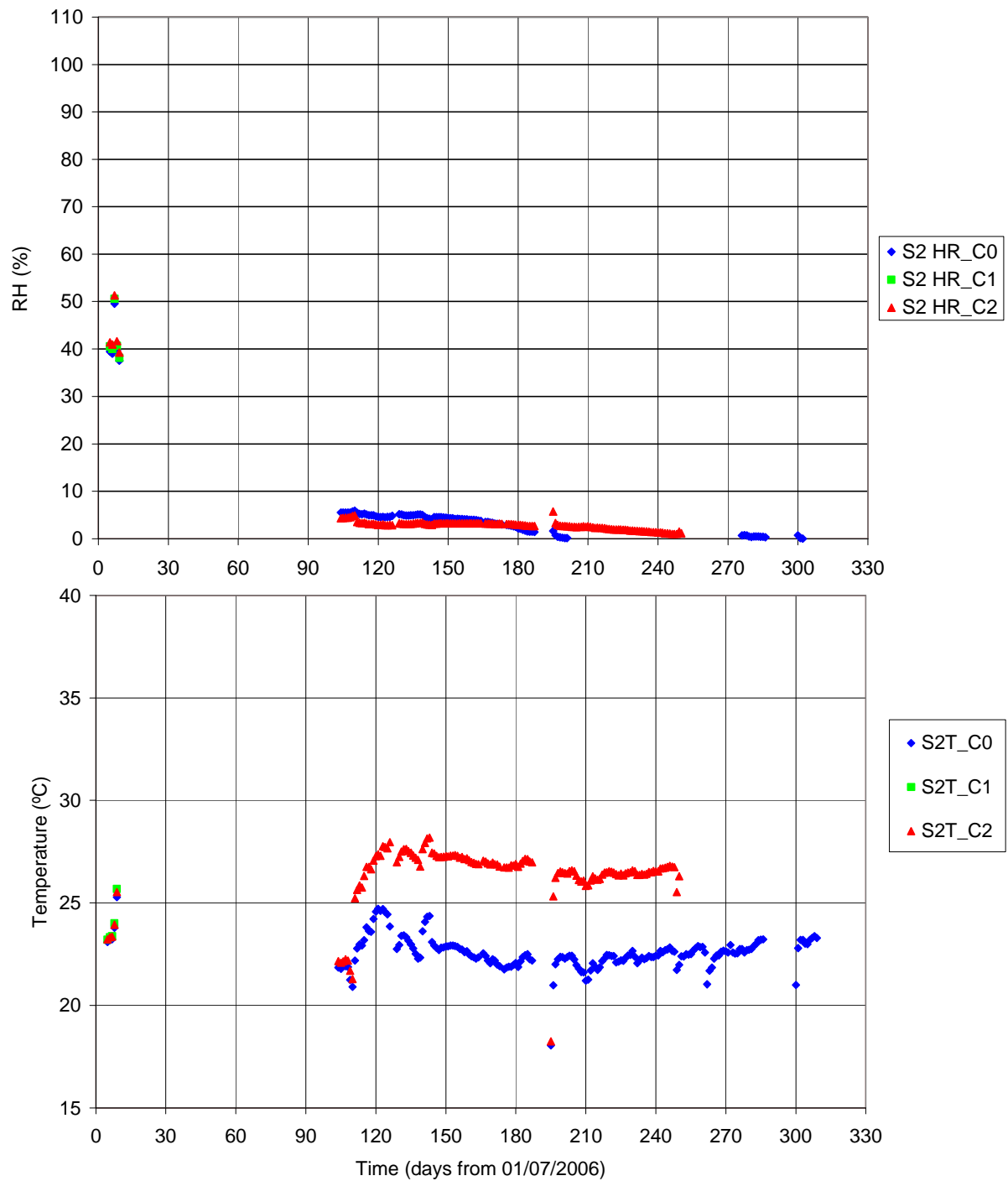

**Figure 5-18: Test S2 NF-PRO phase: RH and T values from rod C: sensors C0, C1, C2 located at coordinates (X= 0.3; Y= 0.425, 0.335, 0.245, respectively).**

[PEBS]

D2.3-1: [Feasibility report on GAME mock-ups](#) & D2.3-2.1: [Reports on GAME status, 1<sup>st</sup> report](#)

Dissemination level: PU

Date of issue of this report: **December 2011**

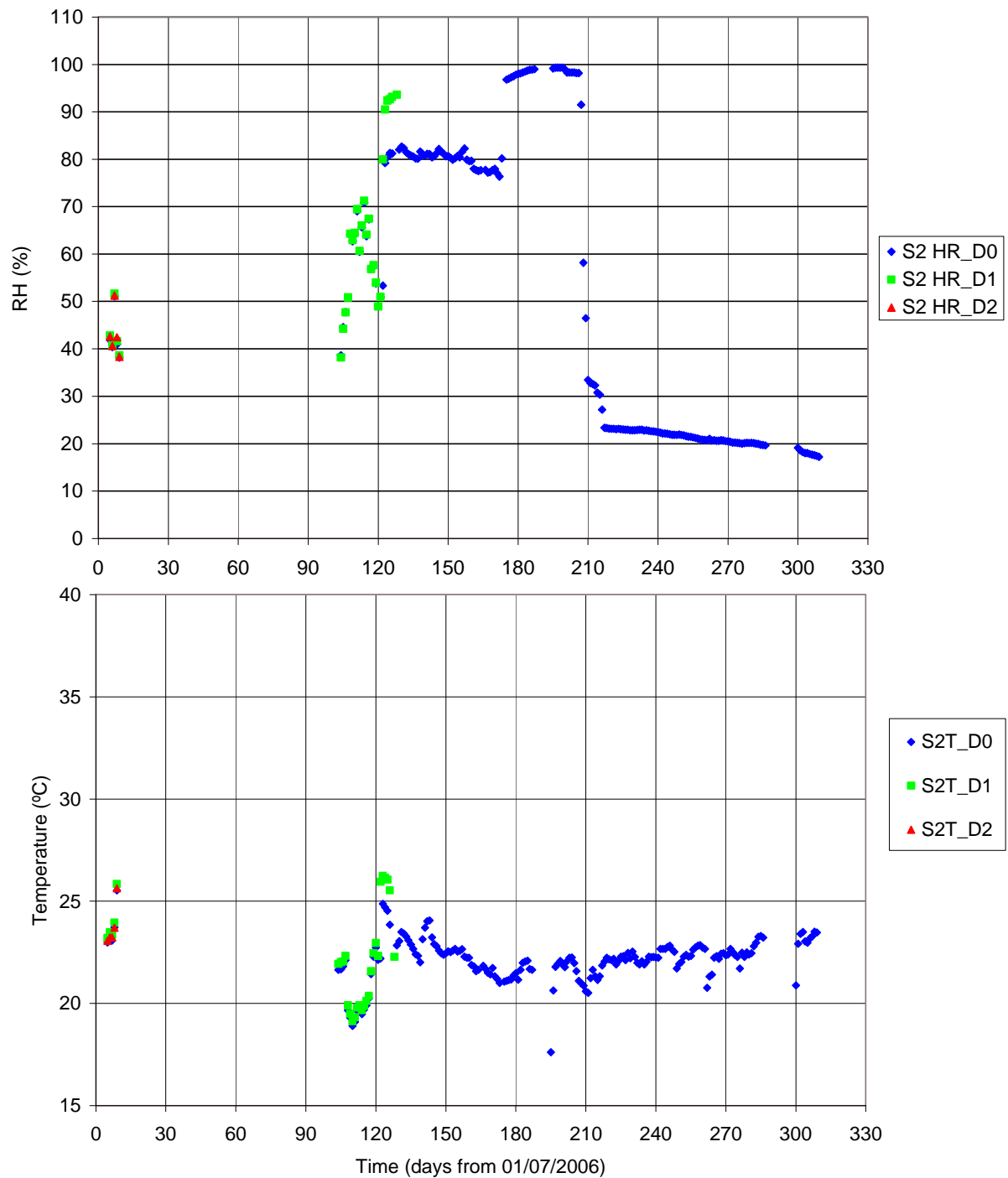

**Figure 5-19: Test S2 NF-PRO phase: RH and T values from rod D: sensors D0, D1, D2 located at coordinates (X= - 0.15; Y= 0.445, 0.355, 0.265, respectively).**

[PEBS]

D2.3-1: [Feasibility report on GAME mock-ups](#) & D2.3-2.1: [Reports on GAME status, 1<sup>st</sup> report](#)

Dissemination level: PU

Date of issue of this report: **December 2011**

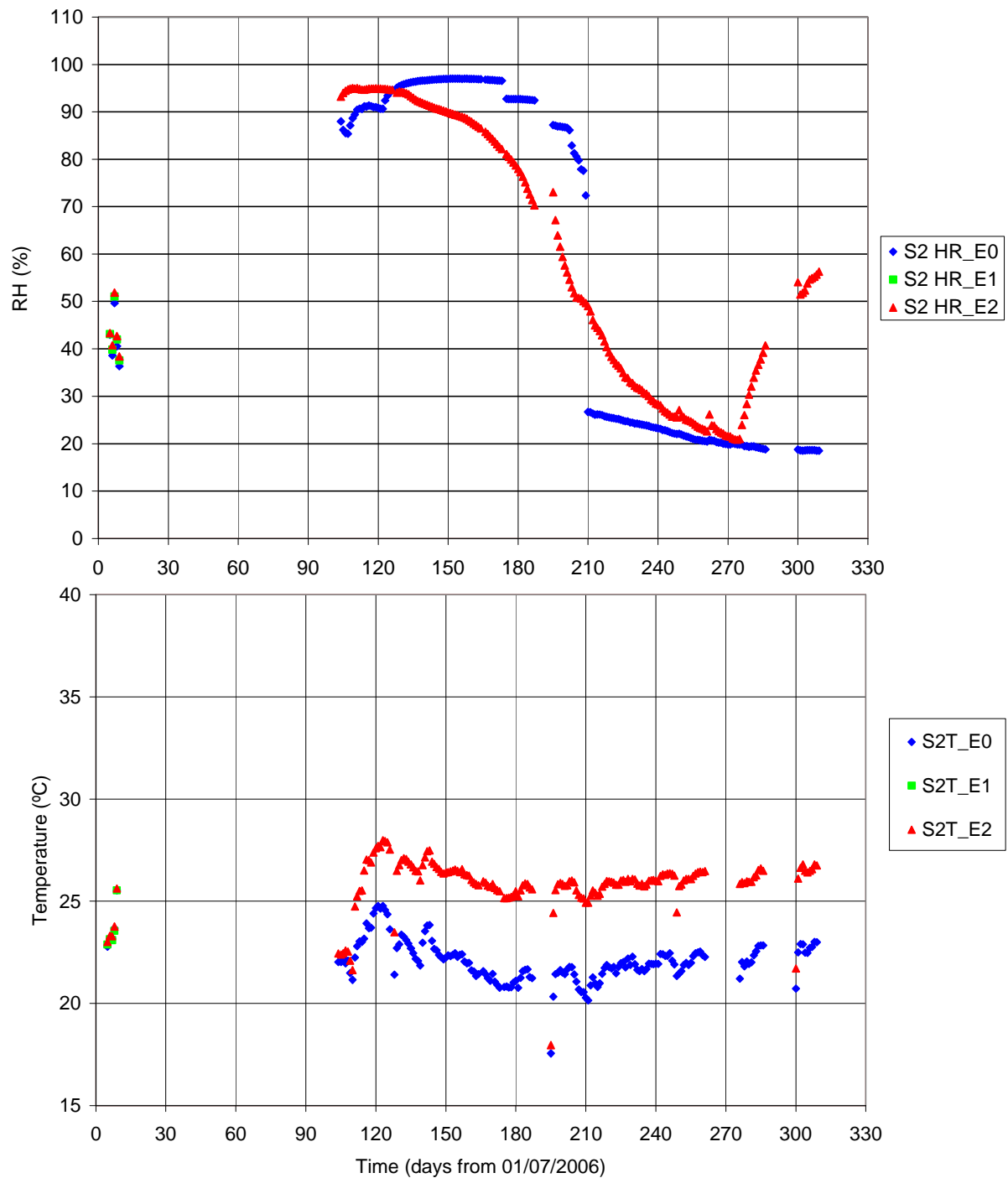

**Figure 5-20: Test S2 NF-PRO phase: RH and T values from rod E: sensors E0, E1, E2 located at coordinates (X= 0.3; Y= 0.465, 0.375, 0.285, respectively).**

[PEBS]

D2.3-1: [Feasibility report on GAME mock-ups](#) & D2.3-2.1: [Reports on GAME status, 1<sup>st</sup> report](#)

Dissemination level: PU

Date of issue of this report: **December 2011**



### 5.3.2 PEBS phase

The whole set of sensors was changed and installed in the new supports. If a sensor resulted damaged during operation, it was replaced as soon as possible. So the number of replacement curves of the sensors indicates the reliability of the test.

The figures are grouped by test, S1 and S2. Figures correspond to the RH and temperature values first by instrumentation rod, from A to E, then by levels (distance to heater): outer (0.245, 0.255, 0.275, 0.295 and 0.315 m), intermediate (0.165, 0.145, 0.185, 0.205 and 0.225 m) and inner (0.075, 0.055, 0.095, 0.115 and 0.135 m)

#### Test S1

From Figure 5-21 to Figure 5-28, it is clear that the damage of the sensors is smaller in test S1 again. Three sensors have been replaced: A1 (possibly damaged from day 360) was changed on day 450 (before a new water injection), and sensor D2 and E0 (damaged on days 290 and 0, respectively) were changed on day 370.

The RH figures (top pictures in the range above) indicate the relative position of the sensor with respect to the hydration surfaces (placed on the inner surface of the structure and the heater surface). So, the RH values are due to installation factors as position, gaps between blocks, distance to hydration surfaces, preferential pathways on such rods, etc... Anyway, most of the values are higher than 90%.

If the sensors are grouped by distance to heater surface (three groups: outer, intermediate and inner; Figure 5-26 to Figure 5-28, respectively), it can be observed that the values of the inner levels (Figure 5-28) are more homogeneous.

The temperature figures (bottom pictures in the above range) show a yearly seasonal tendency over the small waves observed. The expected behaviour, as described in the previous phase, is observed in all the rods and level, but is clearer in the longer rods and during the colder phase of the thermal waves. During the hotter phases, the differences between levels decrease.

#### Test S2

From Figure 5-29 to Figure 5-36, it is clear that the damage of the sensor is greater in test S2. Almost all sensors have been replaced, some of them even twice, before they could be considered as flooded by the saline water. In other cases, the sensors were operating during long time in oversaturated conditions. At least, nine sensors, the closest to the hydration surfaces, were damaged during the water injection event on day 505, other sensors were damaged immediately after the injection on day 450.

As in test S1, the RH figures (bottom pictures in the above range) indicate the relative position of the sensor with respect to the hydration surfaces. So, the expected RH values are modified by the previously cited factors and preferential pathways between the concrete blocks and the rods, etc... Again, most of the measured values are higher than 90% but coming from initial values lower than those of test S1.

The relation of the damage of sensors to the water injection pulses indicates the possibility of some defect in the installation of the rods or related to the interaction between the concrete blocks and the filter levels.

The temperature figures (even numbers in the above range) show the same yearly seasonal tendency with small waves observed in test S1. The expected behaviour is observed in all the rods and level, more clearly in the longer rods and during the colder phases of the thermal waves. During the hotter phases, the differences between levels decrease as above.

---

[PEBS]

D2.3-1: [Feasibility report on GAME mock-ups](#) & D2.3-2.1: [Reports on GAME status, 1<sup>st</sup> report](#)

Dissemination level: PU

Date of issue of this report: **December 2011**

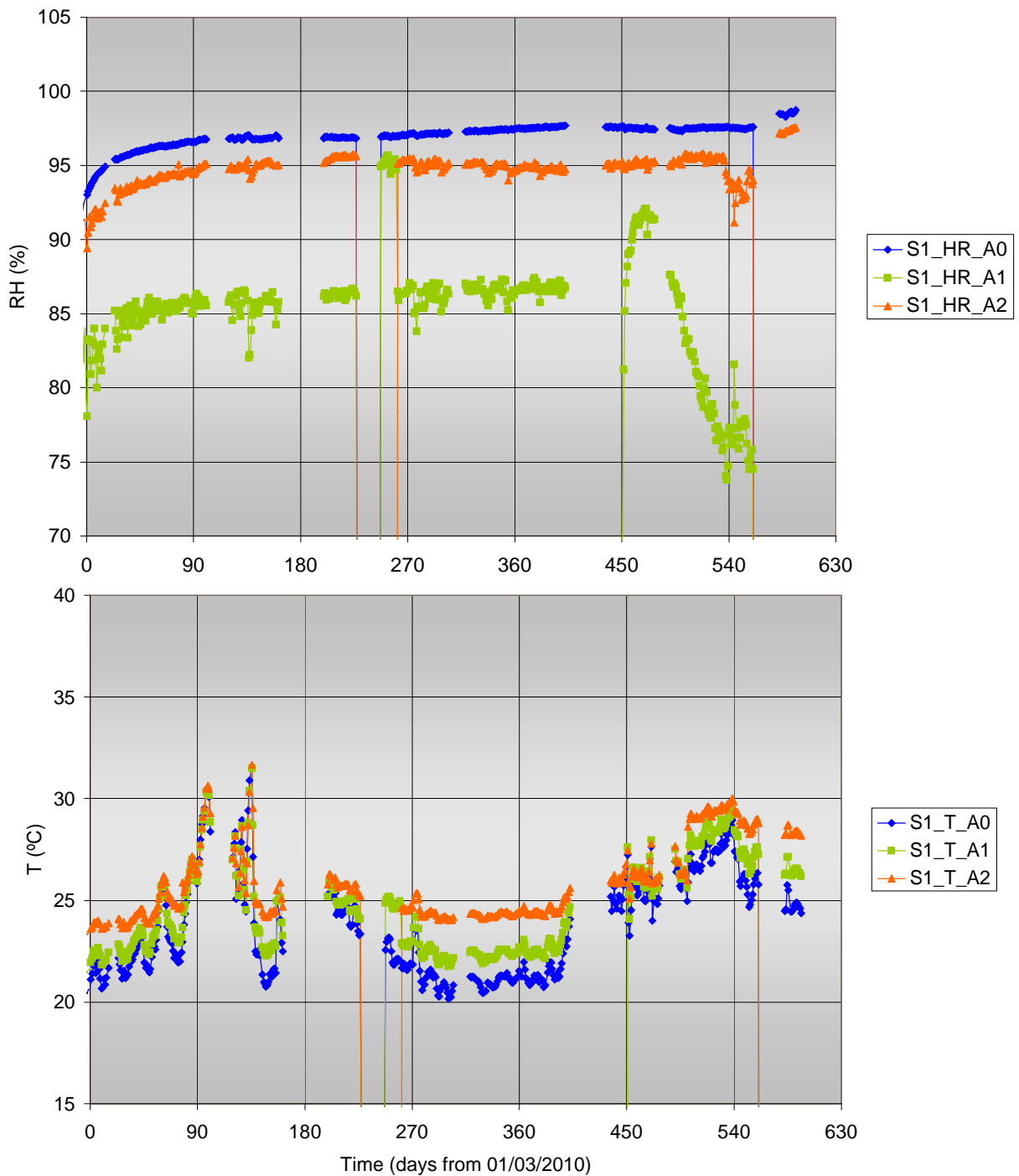

**Figure 5-21: Test S1 PEBS phase: RH and T values from rod A: sensors A0, A1, A2 located at coordinates (X= - 0.3; Y= 0.395, 0.315, 0.225, respectively)**

[PEBS]

D2.3-1: Feasibility report on GAME mock-ups & D2.3-2.1: Reports on GAME status, 1<sup>st</sup> report

Dissemination level: PU

Date of issue of this report: December 2011

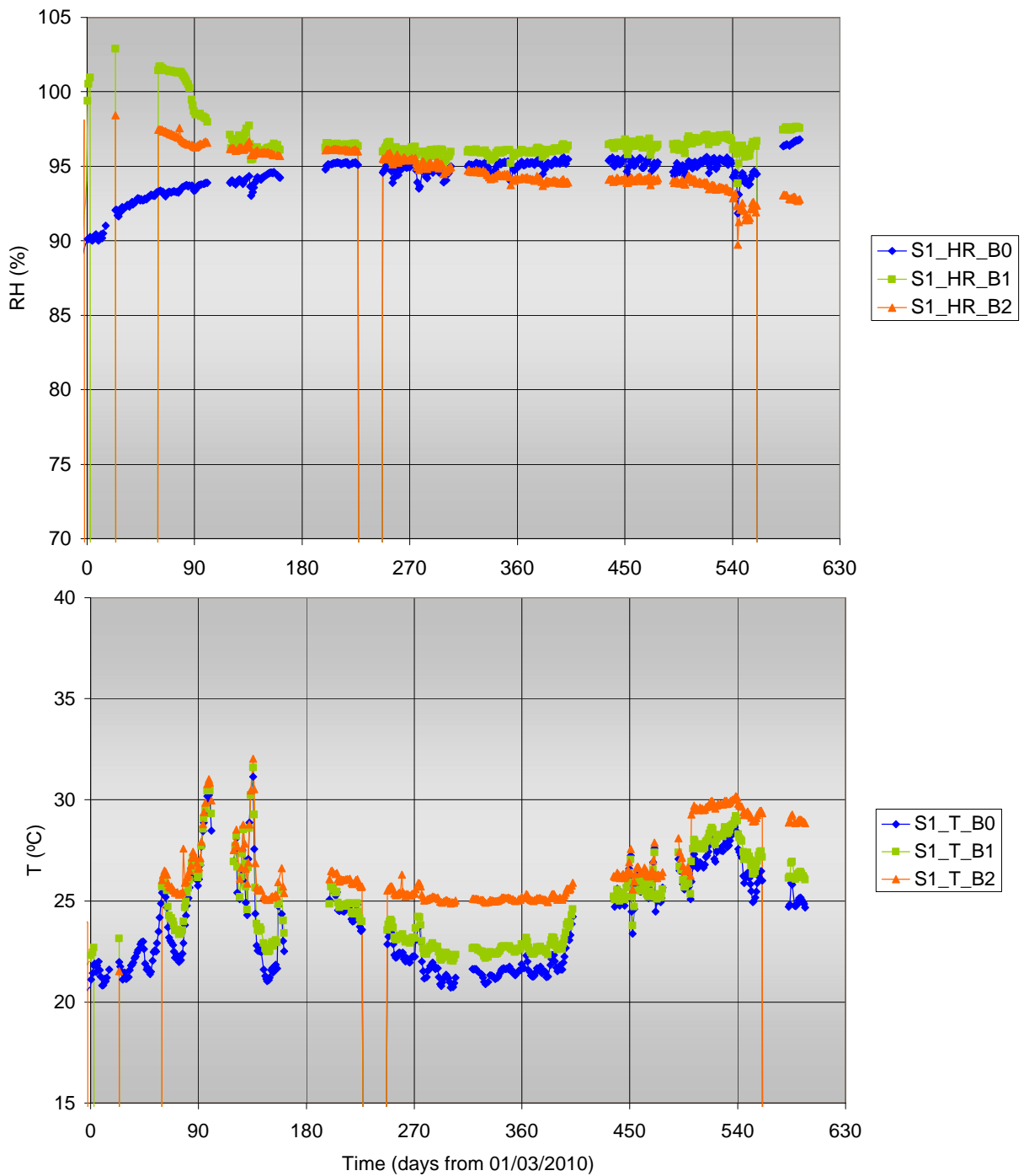

**Figure 5-22: Test S1 PEBS phase: RH and T values from rod B: sensors B0, B1, B2 located at coordinates (X= 0.0; Y= 0.405, 0.295, 0.205, respectively)**

[PEBS]

D2.3-1: Feasibility report on GAME mock-ups & D2.3-2.1: Reports on GAME status, 1<sup>st</sup> report

Dissemination level: PU

Date of issue of this report: December 2011

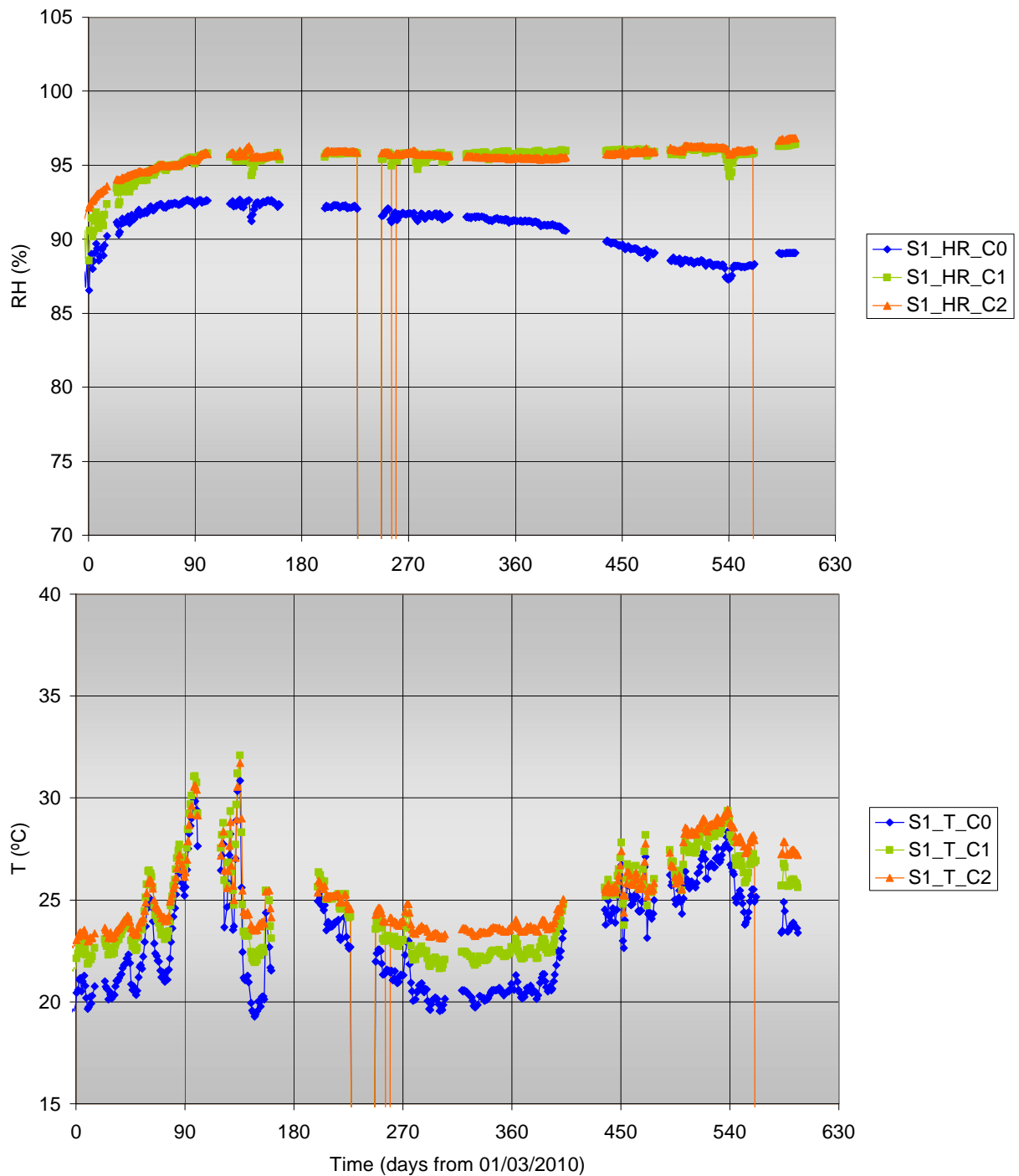

**Figure 5-23: Test S1 PEBS phase: RH and T values from rod C: sensors C0, C1, C2 located at coordinates (X= 0.3; Y= 0.425, 0.335, 0.245, respectively)**

[PEBS]

D2.3-1: Feasibility report on GAME mock-ups & D2.3-2.1: Reports on GAME status, 1<sup>st</sup> report

Dissemination level: PU

Date of issue of this report: December 2011

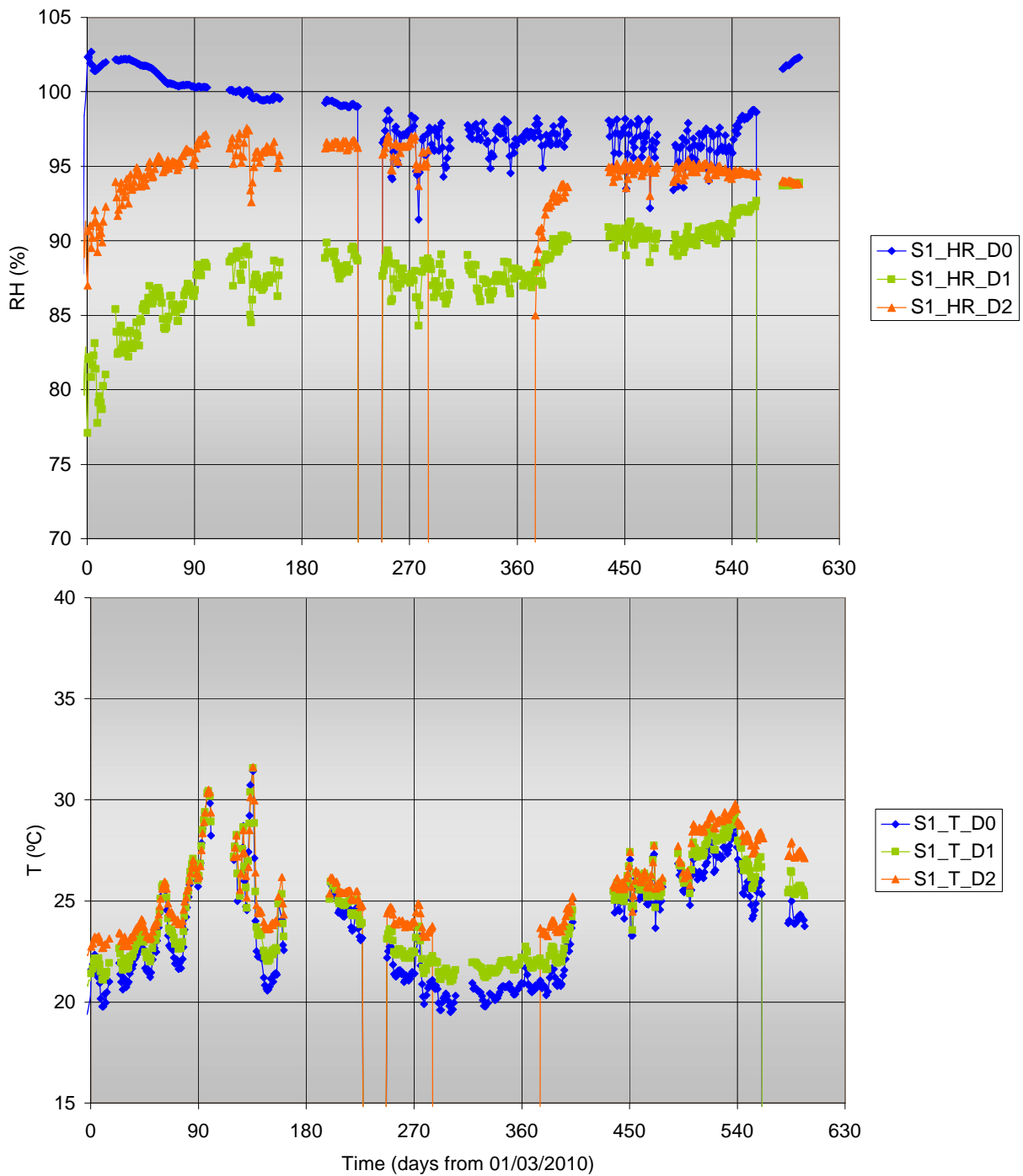

**Figure 5-24: Test S1 PEBS phase: RH and T values from rod D: sensors D0, D1, D2 located at coordinates (X= - 0.15; Y= 0.445, 0.355, 0.265, respectively)**

[PEBS]

D2.3-1: Feasibility report on GAME mock-ups & D2.3-2.1: Reports on GAME status, 1<sup>st</sup> report

Dissemination level: PU

Date of issue of this report: December 2011

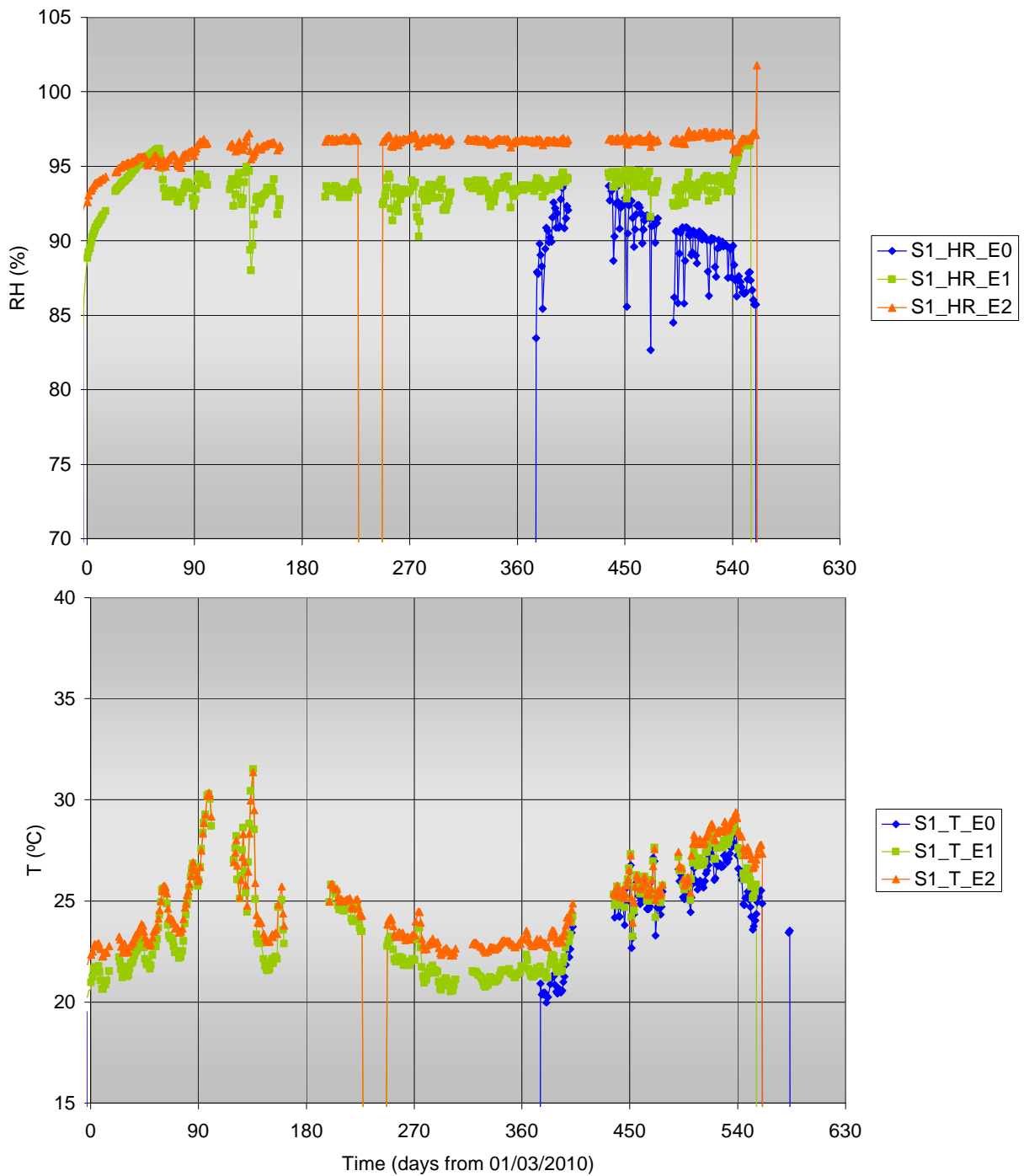

**Figure 5-25: Test S1 PEBS phase: RH and T values from rod E: sensors E0, E1, E2 located at coordinates (X= 0.3; Y= 0.465, 0.375, 0.285, respectively)**

[PEBS]

D2.3-1: [Feasibility report on GAME mock-ups](#) & D2.3-2.1: [Reports on GAME status, 1<sup>st</sup> report](#)

Dissemination level: PU

Date of issue of this report: **December 2011**



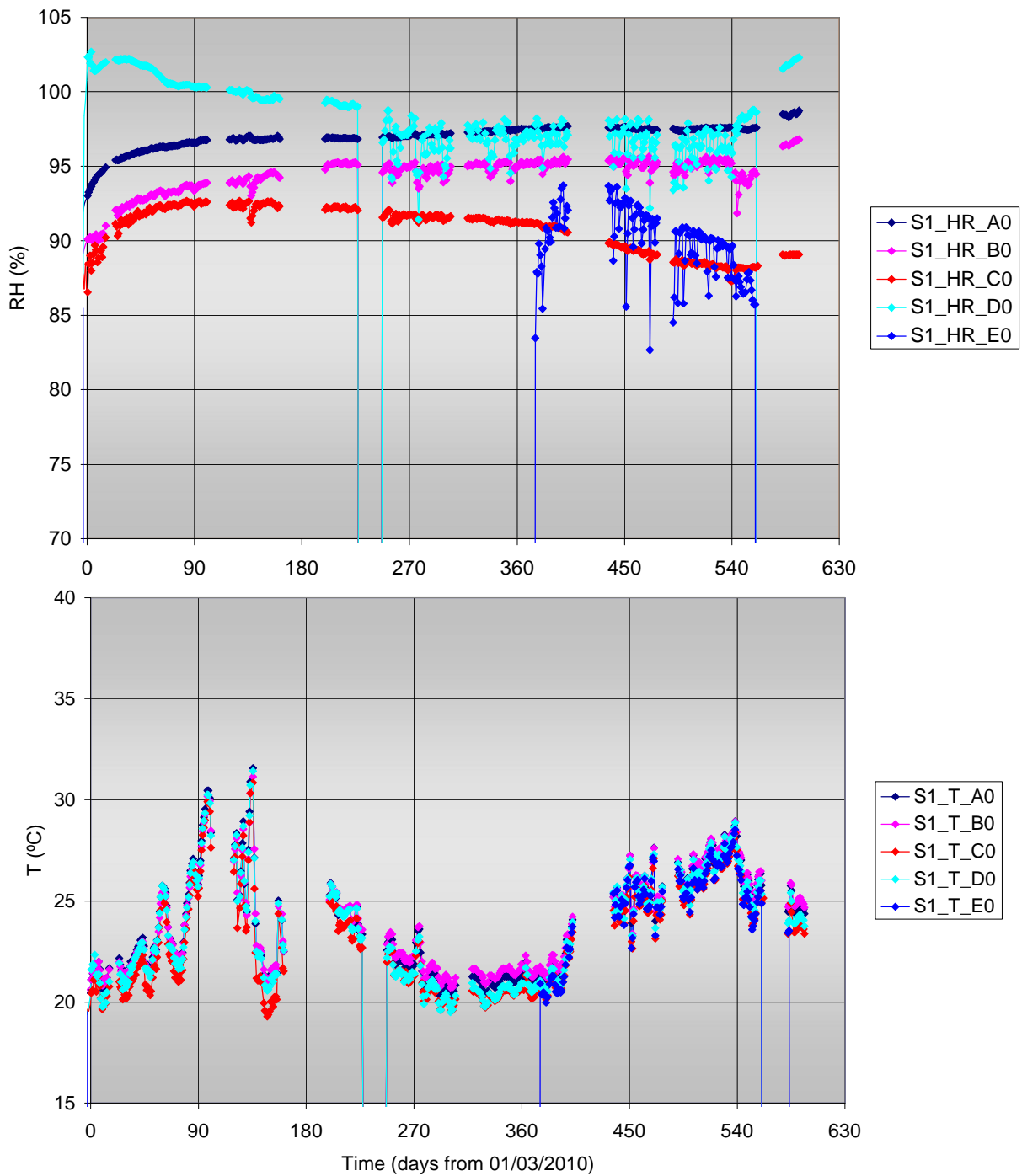

**Figure 5-26: Test S1 PEBS phase: RH and T values from outer levels: (X, Y) location: A0(-0.3, 0.245), B0(0.0, 0.255), C0(0.3,0.275), D0(-0.15, 0.295), E0(0.15, 0.315)**

[PEBS]

D2.3-1: Feasibility report on GAME mock-ups & D2.3-2.1: Reports on GAME status, 1<sup>st</sup> report

Dissemination level: PU

Date of issue of this report: December 2011

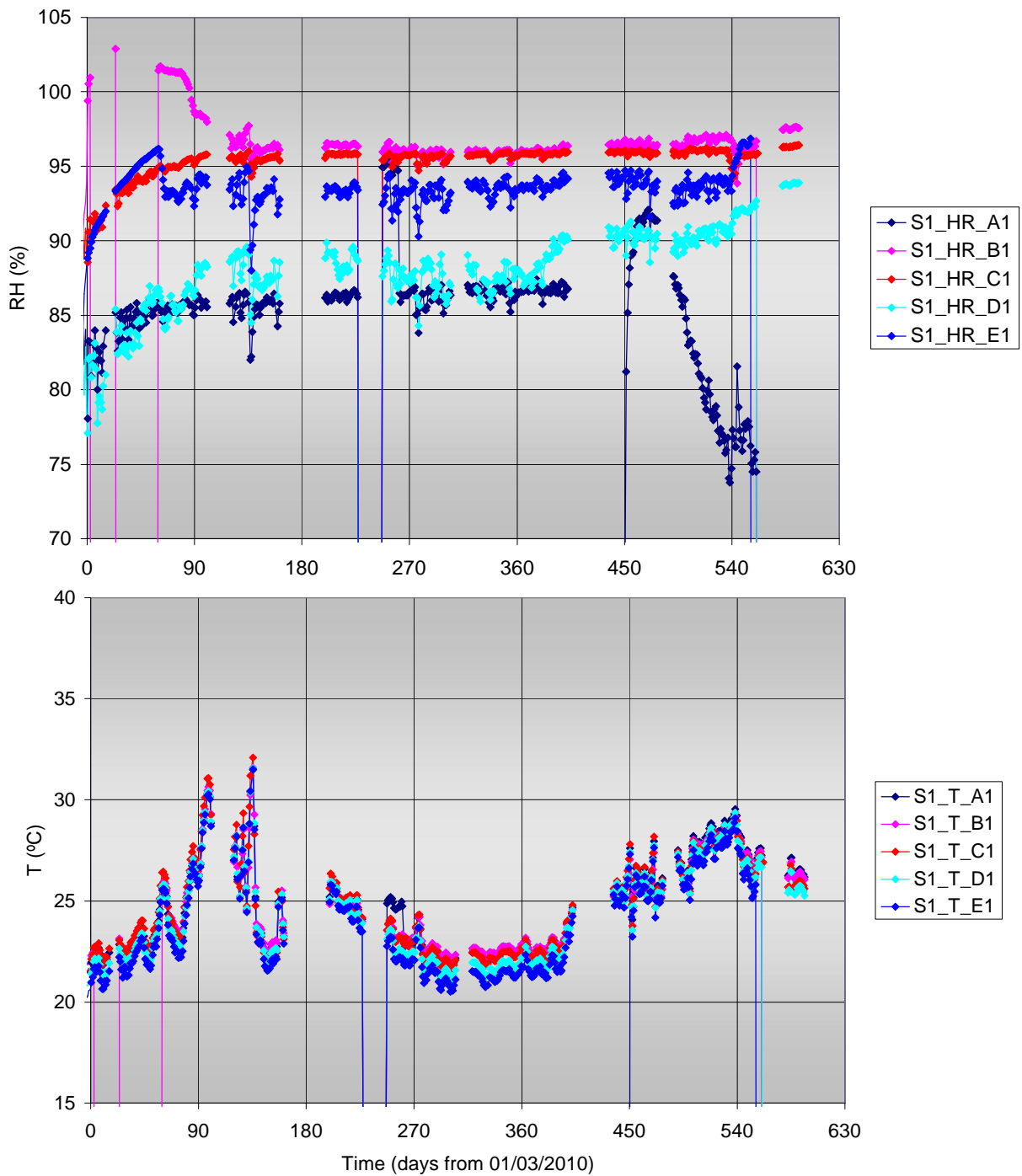

**Figure 5-27: Test S1 PEBS phase: RH and T values from intermediate levels: (X, Y) location: A1(-0.3, 0.165), B1(0.0, 0.145), C1(0.3, 0.185), D1(-0.15, 0.205), E0(0.15, 0.225)**

[PEBS]

D2.3-1: Feasibility report on GAME mock-ups & D2.3-2.1: Reports on GAME status, 1<sup>st</sup> report

Dissemination level: PU

Date of issue of this report: December 2011

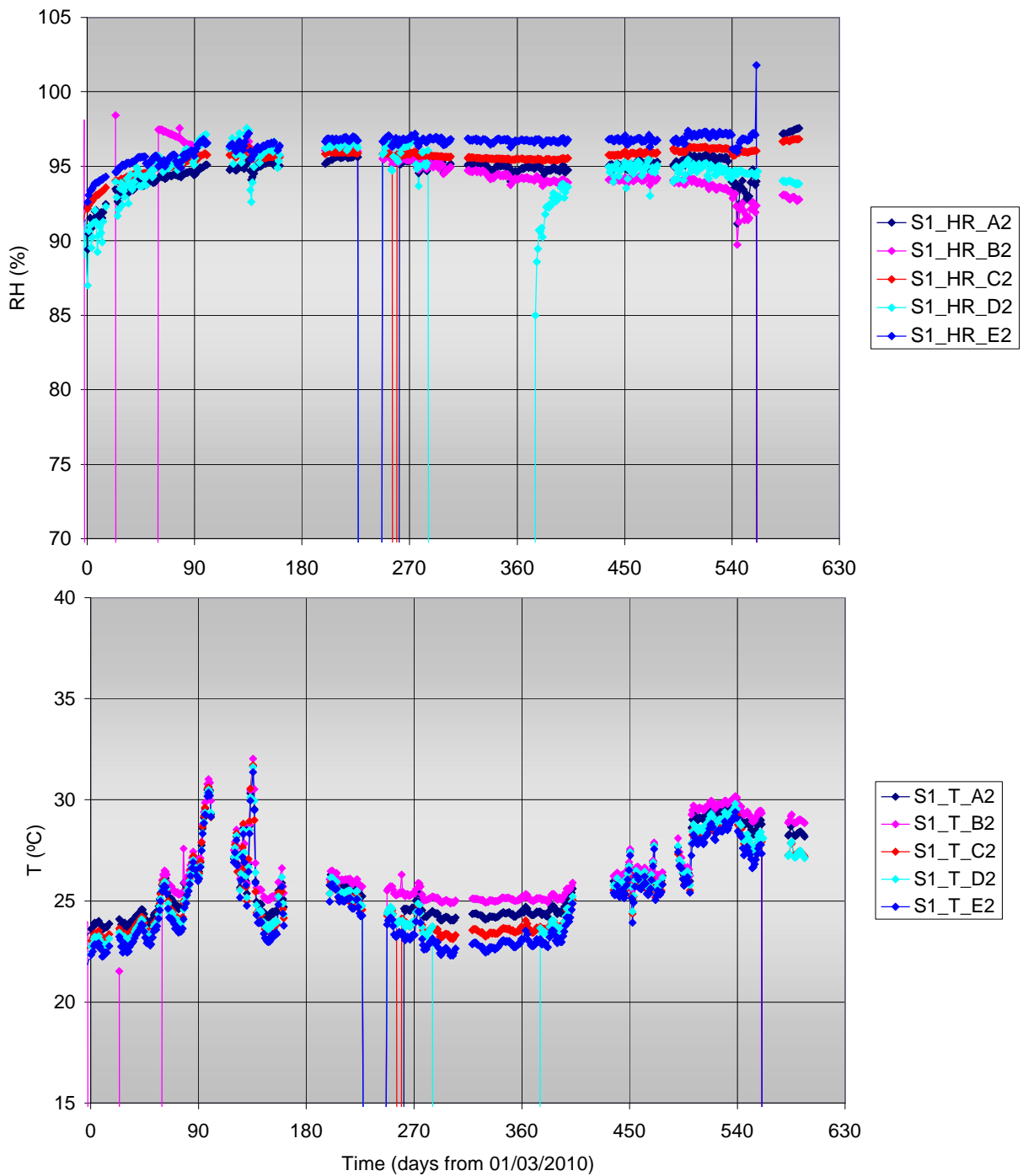

**Figure 5-28: Test S1 PEBS phase: RH and T values from inner levels: (X, Y) location: A2(-0.3, 0.075), B2(0.0, 0.055), C2(0.3, 0.095), D2(-0.15, 0.115), E2(0.15, 0.135)**

**[PEBS]**

D2.3-1: Feasibility report on GAME mock-ups & D2.3-2.1: Reports on GAME status, 1<sup>st</sup> report

Dissemination level: PU

Date of issue of this report: **December 2011**

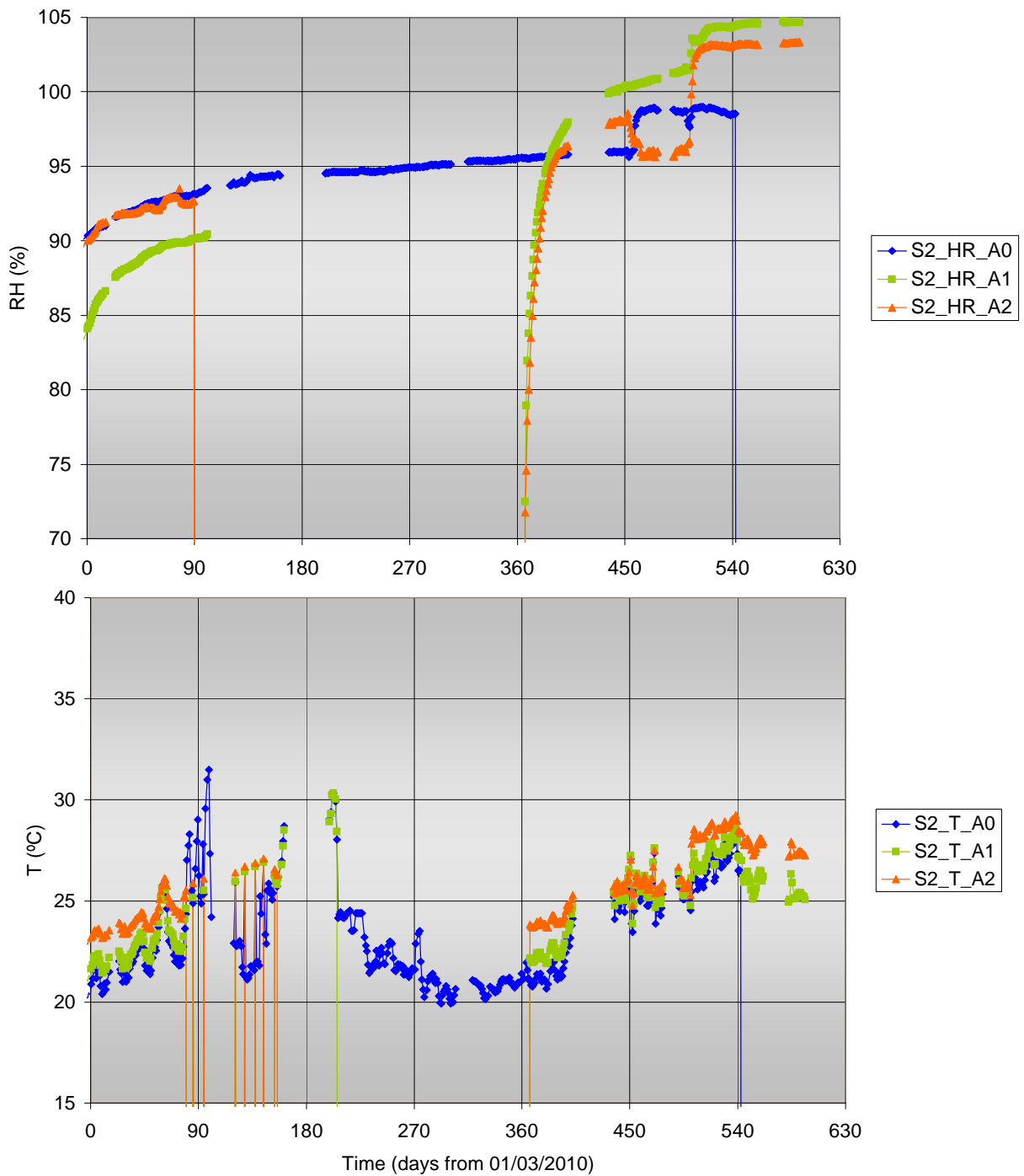

**Figure 5-29: Test S2 PEBS phase: RH and T values from rod A: sensors A0, A1, A2 located at coordinates (X= - 0.3; Y= 0.395, 0.315, 0.225, respectively)**

[PEBS]

D2.3-1: Feasibility report on GAME mock-ups & D2.3-2.1: Reports on GAME status, 1<sup>st</sup> report

Dissemination level: PU

Date of issue of this report: December 2011

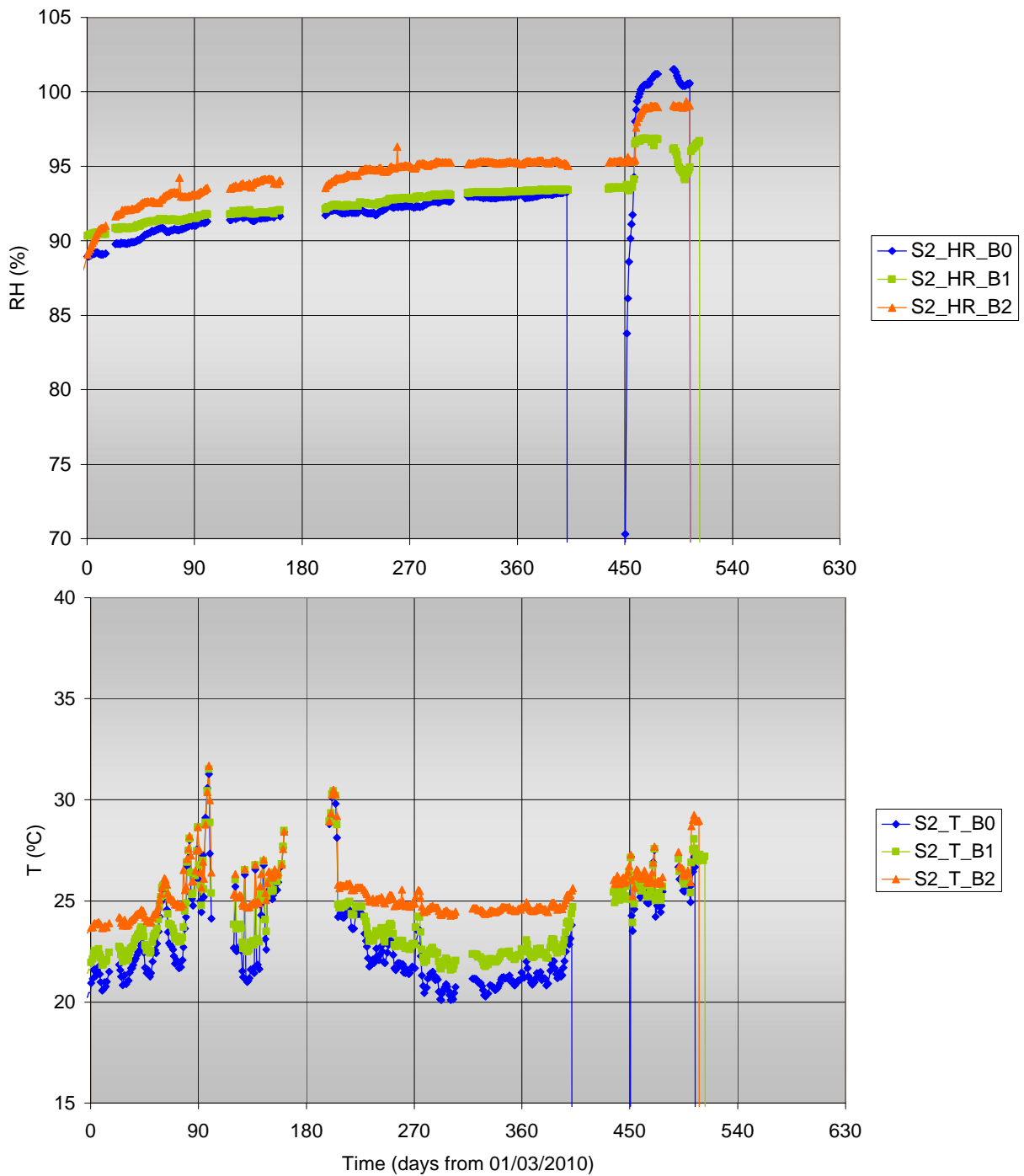

**Figure 5-30: Test S2 PEBS phase: RH and T values from rod B: sensors B0, B1, B2 located at coordinates (X= 0.0; Y= 0.405, 0.295, 0.205, respectively)**

[PEBS]

D2.3-1: [Feasibility report on GAME mock-ups](#) & D2.3-2.1: [Reports on GAME status, 1<sup>st</sup> report](#)

Dissemination level: PU

Date of issue of this report: **December 2011**

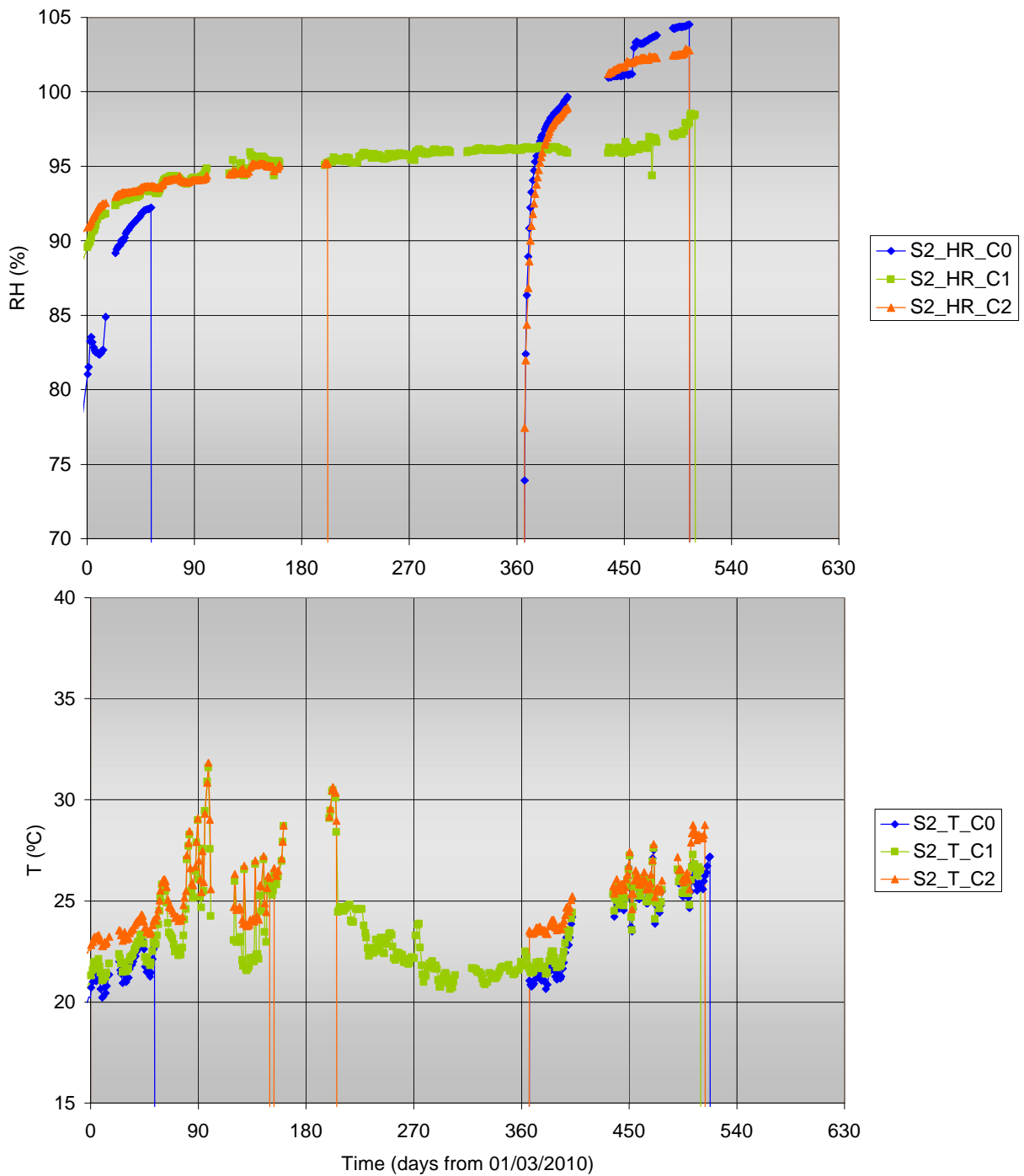

**Figure 5-31: Test S2 PEBS phase: RH and T values from rod C: sensors C0, C1, C2 located at coordinates (X= 0.3; Y= 0.425, 0.335, 0.245, respectively)**

[PEBS]

D2.3-1: Feasibility report on GAME mock-ups & D2.3-2.1: Reports on GAME status, 1<sup>st</sup> report

Dissemination level: PU

Date of issue of this report: December 2011



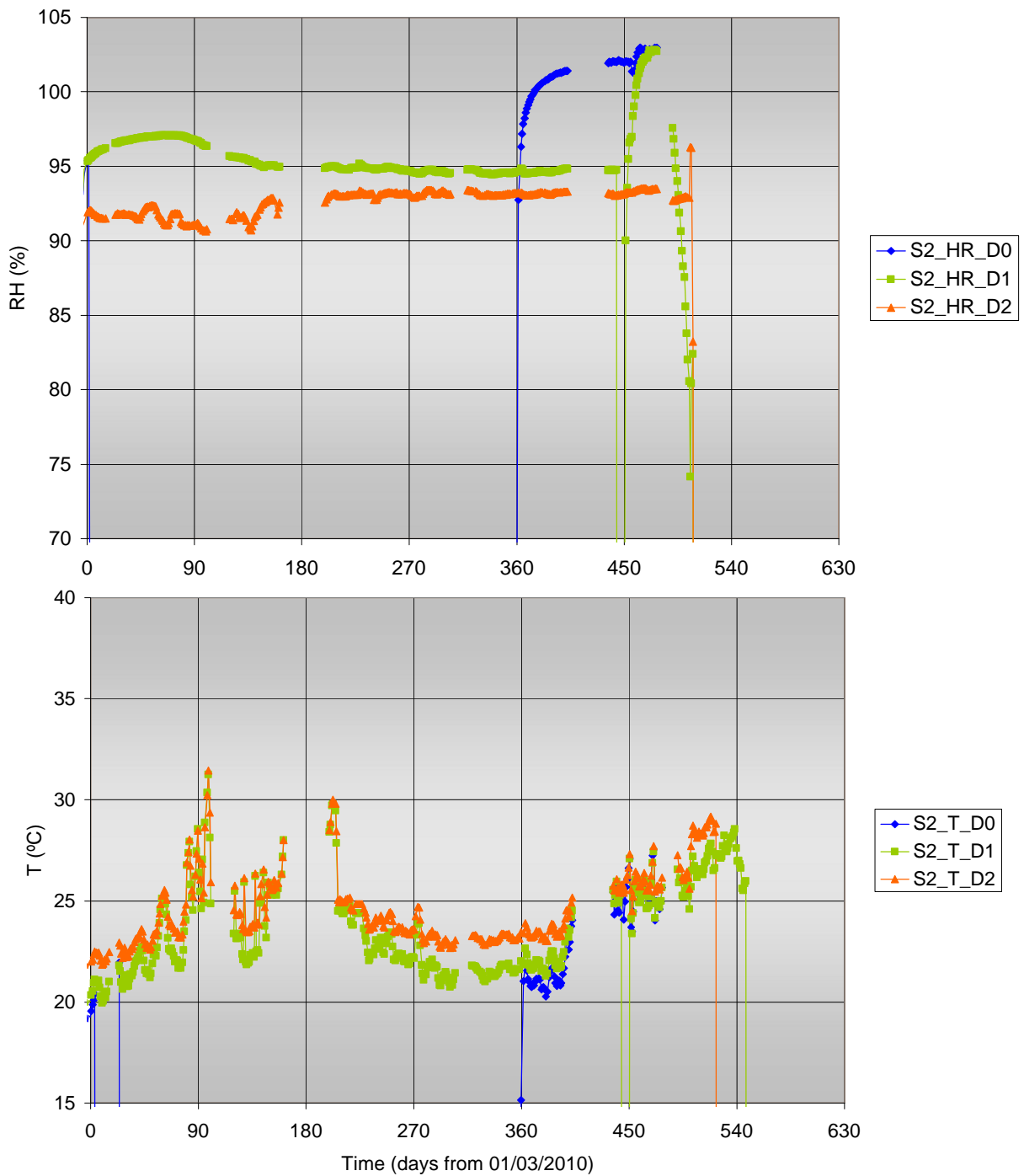

**Figure 5-32: Test S2 PEBS phase: RH and T values from rod D: sensors D0, D1, D2 located at coordinates (X= -0.15; Y= 0.445, 0.355, 0.265, respectively)**

[PEBS]

D2.3-1: Feasibility report on GAME mock-ups & D2.3-2.1: Reports on GAME status, 1<sup>st</sup> report

Dissemination level: PU

Date of issue of this report: December 2011

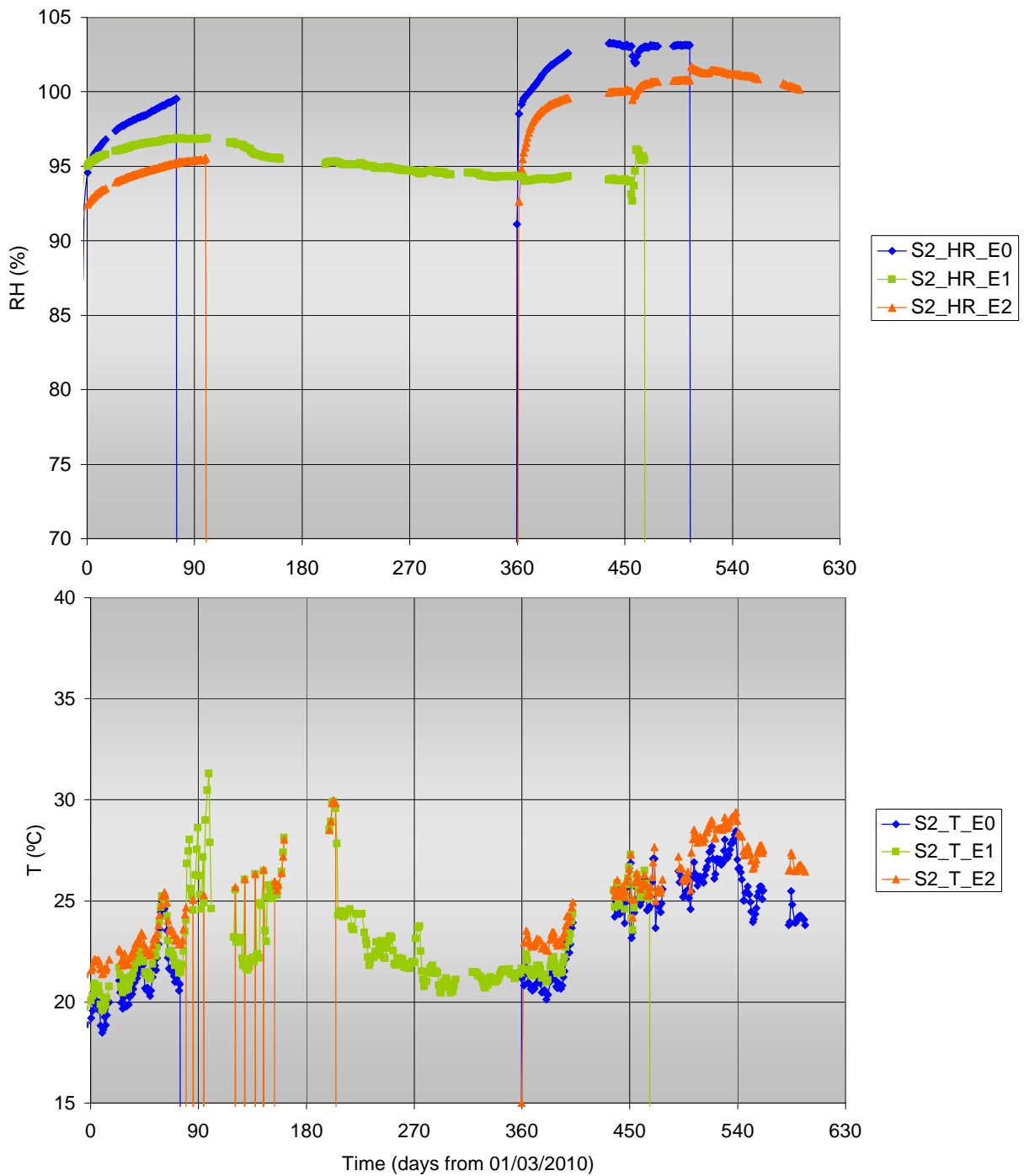

**Figure 5-33: Test S2 PEBS phase: RH and T values from rod E: sensors E0, E1, E2 located at coordinates (X= 0.3; Y= 0.465, 0.375, 0.285, respectively)**

[PEBS]

D2.3-1: Feasibility report on GAME mock-ups & D2.3-2.1: Reports on GAME status, 1<sup>st</sup> report

Dissemination level: PU

Date of issue of this report: December 2011

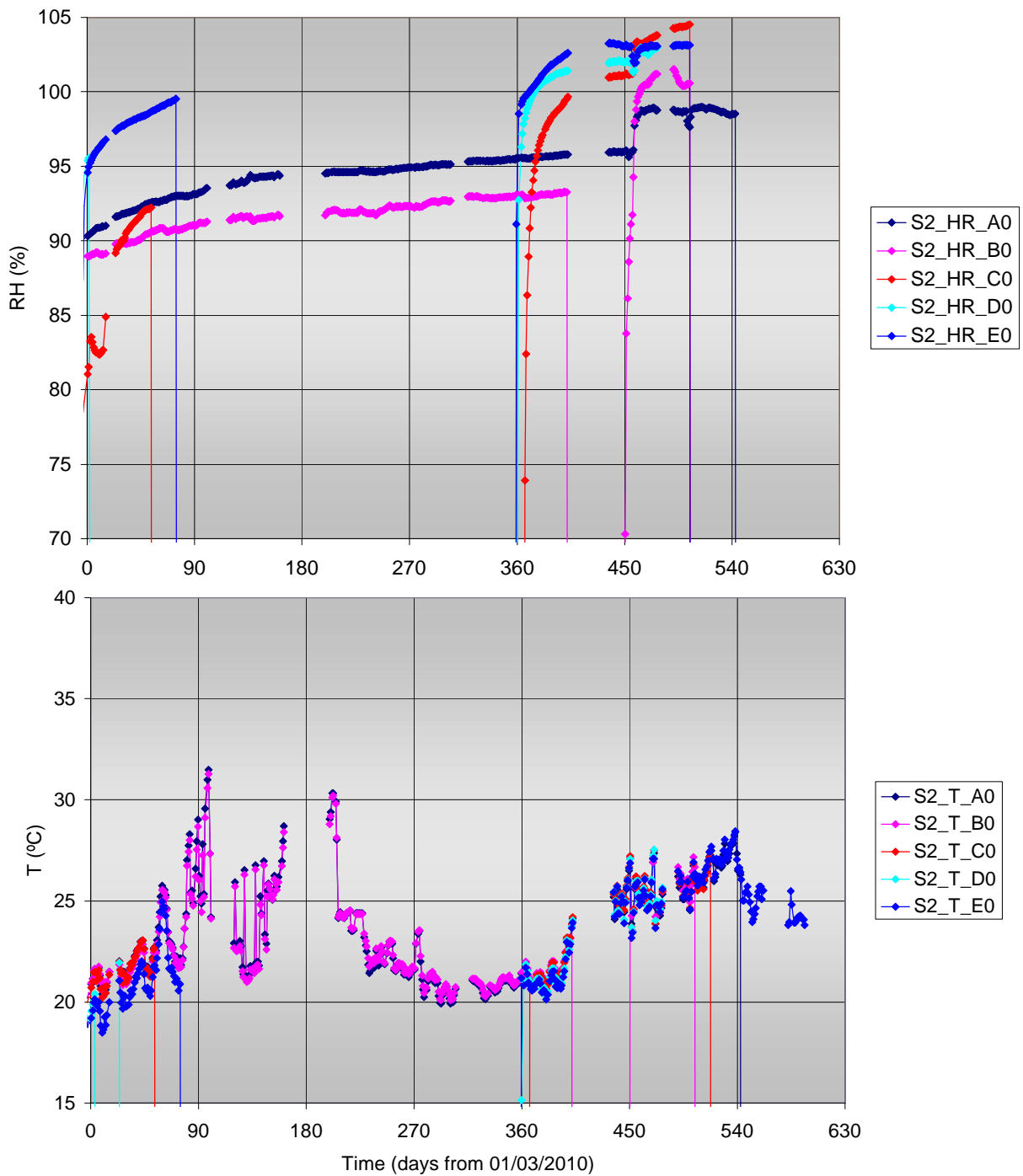

**Figure 5-34: Test S2 PEBS phase: RH and T values from outer levels: (X, Y) location: A0(-0.3, 0.245), B0(0.0, 0.255), C0(0.3,0.275), D0(-0.15, 0.295), E0(0.15, 0.315)**

[PEBS]

D2.3-1: Feasibility report on GAME mock-ups & D2.3-2.1: Reports on GAME status, 1<sup>st</sup> report

Dissemination level: PU

Date of issue of this report: December 2011

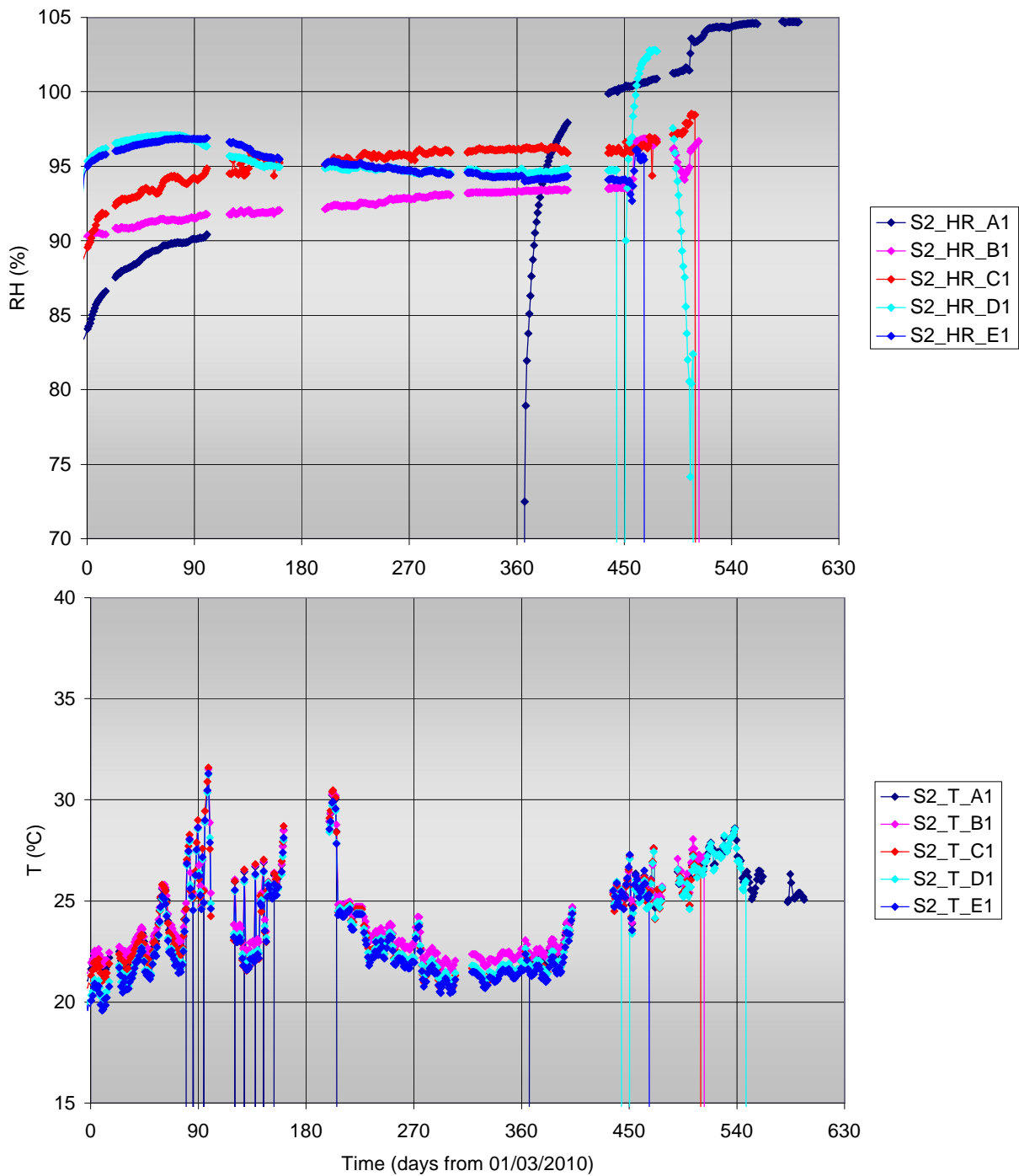

**Figure 5-35: Test S2 PEBS phase: RH and T values from intermediate levels: (X, Y) location: A1(-0.3, 0.165), B1(0.0, 0.145), C1(0.3, 0.185), D1(-0.15, 0.205), E0(0.15, 0.225)**

[PEBS]

D2.3-1: Feasibility report on GAME mock-ups & D2.3-2.1: Reports on GAME status, 1<sup>st</sup> report

Dissemination level: PU

Date of issue of this report: December 2011

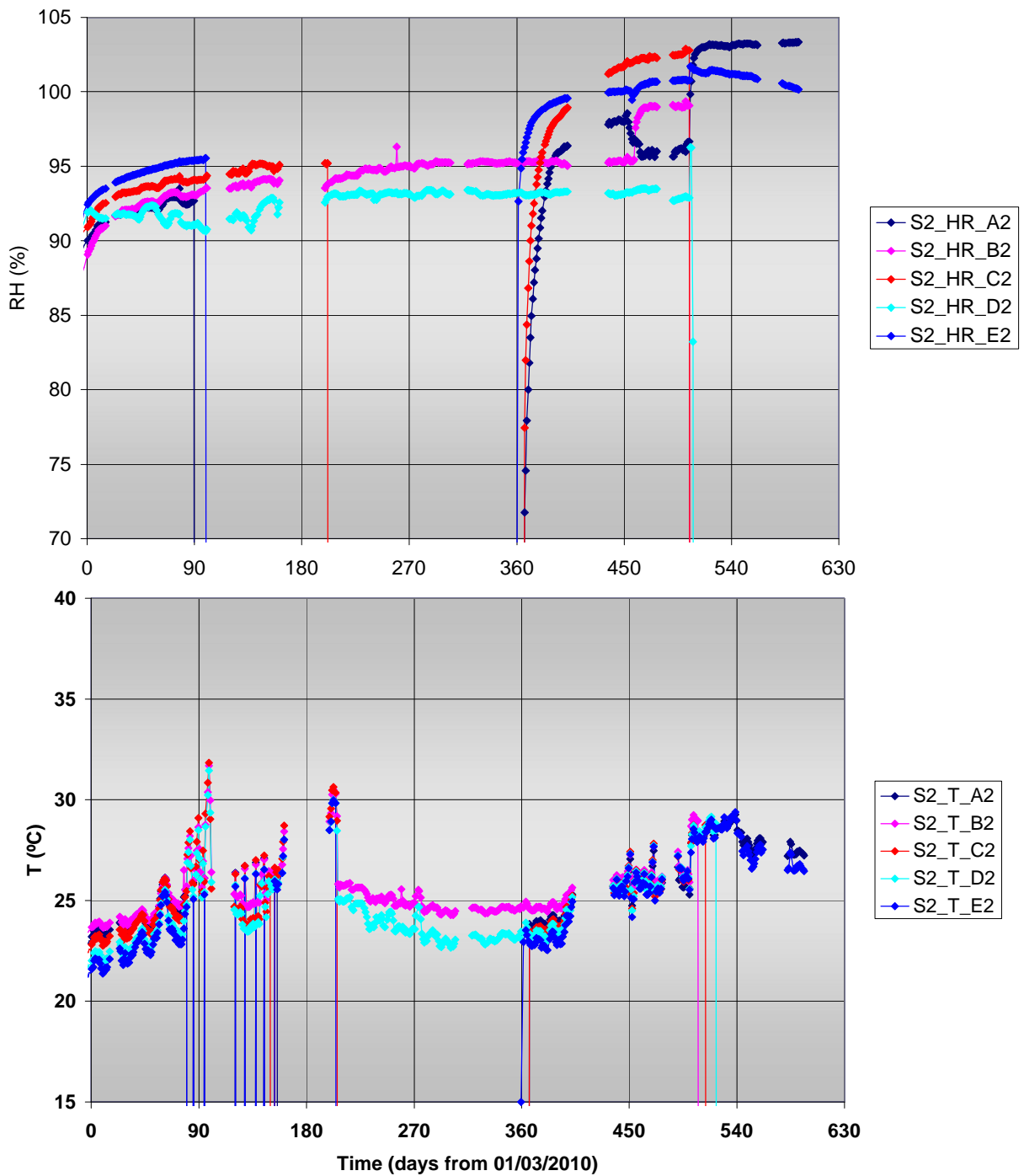

**Figure 5-36: Test S2 PEBS phase: RH and T values from inner levels: (X, Y) location: A2(-0.3, 0.075), B2(0.0, 0.055), C2(0.3, 0.095), D2(-0.15, 0.115), E2(0.15, 0.135)**

[PEBS]

D2.3-1: Feasibility report on GAME mock-ups & D2.3-2.1: Reports on GAME status, 1<sup>st</sup> report

Dissemination level: PU

Date of issue of this report: December 2011

## 6 CONCLUSIONS

The GAME experiment has demonstrated that installation of an EBS and the TH instrumentation in a large-scale experiment, with the hydration and heating infrastructures, is feasible for the granite and clay HLW repository concepts.

However, the present development of the geochemical sensors does not permit to install them in the extreme working conditions of the expansive barrier materials under a thermal load: pressure > 5 MPa, temperature up to 80°C, and harsh saline environment. This is also applicable to all type of sensors with active electronic components, even after protecting them mechanically.

Consequently, the development and implementation of suitable sampling systems was selected as the best option to solve the observed problems.

The modifications in the instrumentation rods to install these new sampling ports and RH/T transmitters were developed and tested during the last two years (2010-2011)

The results indicated that:

1. The sampling ports and the support for the transmitters seem to seal the measuring chambers of the filters, but some leakages come from the instrumentation rods themselves.
2. Change of the damage transmitters is possible.
3. Transmitters that work correctly indicate high RH values and the expected temperature distribution. So, corrosion processes must be going on inside the structures.
4. The experimental setup is fully operative: hydration, heating and data-acquisition systems.
5. There is an excessive rate of damaged sensors in the S2 test, probably due to the presence of preferential pathways through the concrete blocks to the filters or fissures in the pieces of the rods, which expose the transmitters to the saline water.
6. Associated to the point above, there are several leakages, some of them important, related to the insertions of the damaged transmitters. Only one leakage has been detected in test S1 at present.

From these points, the major menace for the feasibility of the experiment is the presence of massive leakages through the insertion of the sensors. At present, this possibility is really small in the test S1, probably due to the internal composition of the test itself, expansive bentonite that helps to seal the leakages; but it is not negligible in the test S2, due to the presence inside of concrete blocks and their gaps and interfaces with the structure (body and covers) and with the rods, which make difficult the sealing effects of the inner bentonite.

Thus, it is considered that experiments can go on under the following conditions:

1. Injection pressure is decreased to prevent the risk of leakages.
2. The S2 test will go on only if the massive leakages are stopped by any way, including the sealing of the problematic insertions and the elimination of the transmitters within.
3. The S1 test will go on with the present configuration. If problems appear, the same solutions will be applied.

---

[PEBS]

D2.3-1: [Feasibility report on GAME mock-ups](#) & D2.3-2.1: [Reports on GAME status, 1<sup>st</sup> report](#)

Dissemination level: PU

Date of issue of this report: **December 2011**



As a last resort, if the problems cannot be solved in a test, it is proposed to continue the normal heating phase with a low-pressure pulse hydration phase. By this way, corrosion processes will be allowed to go on inside the structures, doing possible the post-mortem analysis of the GAME components of the barrier and the comparison of the future data, against the data currently obtained from other corrosion experiments in cells.

---

[PEBS]

D2.3-1: [Feasibility report on GAME mock-ups](#) & D2.3-2.1: [Reports on GAME status, 1<sup>st</sup> report](#)

Dissemination level: PU

Date of issue of this report: **December 2011**

## 7 REFERENCES

DANAHER CONTROLS (2004): MLC 9000+: Full User Guide. 59367, Edición 1. Marzo 04. <http://www.danacon.com>.

ENRESA (1994): Almacenamiento Geológico Profundo de residuos radioactivos de alta actividad (AGP). Conceptos preliminares de referencia. Publicación Técnica 7/94. Madrid. 60 pp.

ENRESA (1995): Almacenamiento geológico profundo de residuos radioactivos de alta actividad (AGP). Diseños conceptuales genéricos. Publicación Técnica 11/95. Madrid. 105 pp.

ENRESA (2006): FEBEX Full-scale Engineered Barriers Experiment. Updated Final Report: 1994-2004.

Epoxy Technology (2001): EPOTEK 730 Epoxy adhesive data sheet. Rev.III. <http://www.epotek.com>

Epoxy Technology (2003): EPOTEK 509EBT-M Epoxy adhesive data sheet. Doc. #23. <http://www.epotek.com>

Martín P.L. & Barcala J.M. (2007a): Construction and beginning of operation of mini mock-up (WP2.3) Contract Number: FI6W-CT-2003-02389. NF-Pro project DELIVERABLE (D-Nº: 2.3.3)

Martín P.L. & Barcala J.M. (2007b): Construction and start of operation of GAME mini mock-up (WP 2.4). Contract Number: FI6W-CT-2003-02389. NF-Pro project DELIVERABLE (D-Nº: 2.4.3)

Martín P.L. & Barcala J.M. (2007c): Game data periodic report (WP2.3) Contract Number: FI6W-CT-2003-02389. NF-Pro project DELIVERABLE (D-Nº: 2.3.4) S1

Martín P.L. & Barcala J.M. (2007d): Periodic report on evolution of parameters in the mini mock-up (WP2.4) Contract Number: FI6W-CT-2003-02389. NF-Pro project DELIVERABLE (D-Nº: 2.4.4) S2

Martín, P.L. & Barcala, J.M. (2007e): Final Activity Report for CIEMAT: WP 2.4. Contract Number: FI6W-CT-2003-02389. NF-Pro project DELIVERABLE (D-Nº: 2.4.6).

SENSIRION (2003): Evaluation Kit EK-H3 for SHTxx Relative Humidity & Temperature sensor. Version 2.3. <http://www.sensirion.com>.

SENSIRION (2005a): SHT1x / SHT7x Relative Humidity & Temperature Sensor System. v2.04, May 2005. <http://www.sensirion.com>.

SENSIRION (2005b): SHTxx Application Note CRC Rev 1.06, May 2005. <http://www.sensirion.com>.

SENSIRION (2005c): SHTxx Application Note Non-Linearity Compensation Rev. 1.32, May 2005. <http://www.sensirion.com>.

SENSIRION (2005d): SHTxx Application Note Status Register Rev 1.24, May 2005. <http://www.sensirion.com>.

Turrero M.J., Torres E., Martín P.L. & Barcala J.M. (2007): Final Activity Report for CIEMAT WP 2.3. Contract Number: FI6W-CT-2003-02389. NF-Pro project DELIVERABLE (D-Nº: 2.3.6)

---

[PEBS]

D2.3-1: [Feasibility report on GAME mock-ups](#) & D2.3-2.1: [Reports on GAME status, 1<sup>st</sup> report](#)

Dissemination level: PU

Date of issue of this report: **December 2011**

VICALDE (2005): Manual de fabricación OF-1686: dos estructuras para maquetas. Talleres Vicalde S.A., Llodio, Spain.

---

[PEBS]

D2.3-1: [Feasibility report on GAME mock-ups](#) & D2.3-2.1: [Reports on GAME status, 1<sup>st</sup> report](#)

Dissemination level: PU

Date of issue of this report: **December 2011**